

Digital Temperature Controller (Simple Type)

E5CC-800/E5CC-B-800/E5CC-U-800 (48 × 48 mm)

**Large White PV Display That's Easier to Read.
Easy to Use, from Model Selection to
Setup and Operation.
Models with Push-In Plus Terminal
Blocks Added to Lineup.**



- The white PV display with a height of 15.2 mm improves visibility.
- High-speed sampling at 50 ms.
- Select from models with screw terminal blocks, models with Push-In Plus terminal blocks for reduced wiring work, and Plug-in Models that can be removed from the terminal block.
- Short body with depth of only 60 mm. (Screw Terminal Blocks)
- Easy connections to a PLC with programless communications. Use component communications to link Temperature Controllers to each other.



Refer to your OMRON website for the most recent information on applicable safety standards.

Refer to Safety Precautions on page 62.

Main I/O Functions

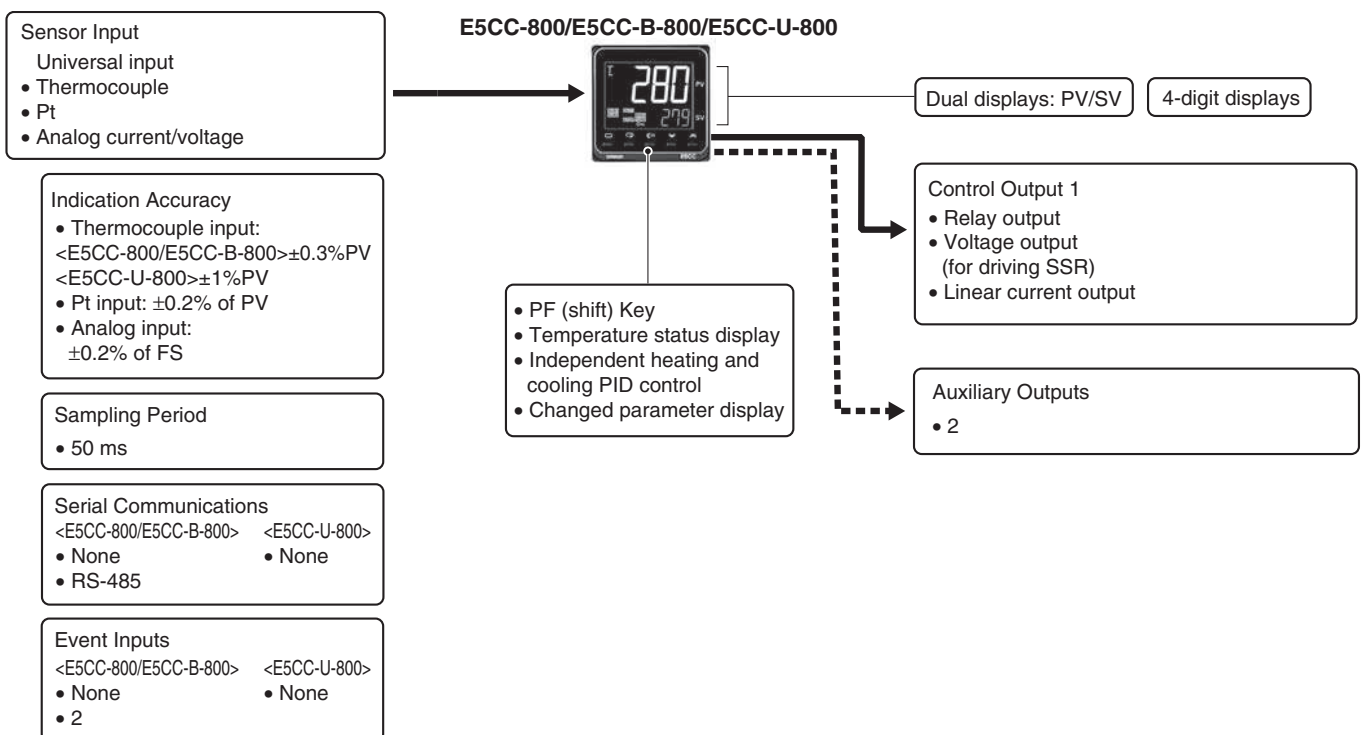

E5CC-800/E5CC-B-800/E5CC-U-800

Model Number Legend and Standard Models

Model Number Legend

● Models with Screw Terminal Blocks

E5CC-800 48 × 48 mm

Control output 1	Auxiliary output	Communications	Heater burnout	Event inputs	Power supply voltage	Model
Relay output	Two	-	-	-	100 to 240 VAC	E5CC-RX2ASM-800
Voltage output						E5CC-QX2ASM-800
Linear current output						E5CC-CX2ASM-800
Relay output					24 VAC/VDC	E5CC-RX2DSM-800
Voltage output						E5CC-QX2DSM-800
Linear current output						E5CC-CX2DSM-800
Relay output		One	-	Two	100 to 240 VAC	E5CC-RX2ASM-801
Voltage output						E5CC-QX2ASM-801
Relay output						E5CC-RX2DSM-801
Voltage output					24 VAC/VDC	E5CC-QX2DSM-801
Relay output						E5CC-RX2ASM-802
Voltage output						E5CC-QX2ASM-802
Relay output		RS-485	-	-	100 to 240 VAC	E5CC-RX2ASM-802
Voltage output						E5CC-QX2ASM-802
Relay output						E5CC-RX2DSM-802
Voltage output					24 VAC/VDC	E5CC-QX2DSM-802
Linear current output						E5CC-CX2ASM-804
Linear current output						E5CC-CX2DSM-804

Note: Draw-out-type models of the E5CC-800 are available. Ask your OMRON representative for details.

● Models with Push-In Plus Terminal Blocks

E5CC-B-800 48 × 48 mm

Control output 1	Auxiliary output	Communications	Heater burnout	Event inputs	Power supply voltage	Model	
Relay output	Two	-	-	-	100 to 240 VAC	E5CC-RX2ABM-800	
Voltage output						E5CC-QX2ABM-800	
Linear current output						E5CC-CX2ABM-800	
Relay output		RS-485	One			Two	E5CC-RX2ABM-802
Voltage output							E5CC-QX2ABM-802
Linear current output							E5CC-CX2ABM-804

● Plug-in Models

E5CC-U-800 48 × 48 mm

Control output 1	Auxiliary output	Communications	Heater burnout	Event inputs	Power supply voltage	Model
Relay output	Two	-	-	-	100 to 240 VAC	E5CC-RW2AUM-800
Voltage output						E5CC-QX2AUM-800
Relay output					24 VAC/VDC	E5CC-RW2DUM-800
Voltage output						E5CC-QX2DUM-800

Heating and Cooling Control

● Using Heating and Cooling Control

(1) Control Output Assignment

An auxiliary output is used as the cooling control output.

(2) Control

If PID control is used, you can set PID control separately for heating and cooling.

This allows you to handle control systems with different heating and cooling response characteristics.

Optional Products (Order Separately)

Terminal Covers (for E5CC-800)

Model
E53-COV17
E53-COV23 (3pcs)

Note: The E53-COV10 cannot be used.
Refer to page 14 for the mounted dimensions.

Waterproof Packing

Model
Y92S-P8

Note: This Waterproof Packing is provided only with E5CC-800/
E5CC-B-800 Controllers.
The E5CC-U-800 cannot be waterproofed even if the
Waterproof Packing is attached.

Current Transformers (CTs)

Hole diameter	Model
5.8 mm	E54-CT1
5.8 mm	E54-CT1L *
12.0 mm	E54-CT3
12.0 mm	E54-CT3L *

* Lead wires are included with these CTs. If UL certification is
required, use these CTs.

Adapter

Model
Y92F-45

Note: Use this Adapter when the panel has already been prepared for
an E5B□ Controller.

DIN Track Mounting Adapter (for E5CC-800)

Model
Y92F-52

Sockets (for E5CC-U-800)

Type	Model
Front-connecting Socket	P2CF-11
Front-connecting Socket with Finger Protection	P2CF-11-E
Back-connecting Socket	P3GA-11
Terminal Cover for Back-connecting socket with Finger Protection	Y92A-48G

Waterproof Cover

Model
Y92A-48N

Mounting Adapter

Model
Y92F-49

Note: This Mounting Adapter is provided with the Digital Temperature
Controller.

Front Covers

Type	Model
Hard Front Cover	Y92A-48H
Soft Front Cover	Y92A-48D

E5CC-800/E5CC-B-800/E5CC-U-800

Specifications

Ratings

Power supply voltage		A in model number: 100 to 240 VAC, 50/60 Hz D in model number: 24 VAC, 50/60 Hz; 24 VDC
Operating voltage range		85% to 110% of rated supply voltage
Power consumption		Models with option selection of 800: 5.2 VA max. at 100 to 240 VAC, and 3.1 VA max. at 24 VAC or 1.6 W max. at 24 VDC All other models: 6.5 VA max. at 100 to 240 VAC, and 4.1 VA max. at 24 VAC or 2.3 W max. at 24 VDC
Sensor input		Temperature input Thermocouple: K, J, T, E, L, U, N, R, S, B, C/W, or PL II Platinum resistance thermometer: Pt100 or JPt100 Infrared temperature sensor (ES1B): 10 to 70°C, 60 to 120°C, 115 to 165°C, or 140 to 260°C Analog input Current input: 4 to 20 mA or 0 to 20 mA Voltage input: 1 to 5 V, 0 to 5 V, 0 to 10 V, or 0 to 50 mV (The 0 to 50 mV range applies to the E5CC-U-800 only for those manufactured in May 2014 or later.)
Input impedance		Current input: 150 Ω max., Voltage input: 1 MΩ min. (Use a 1:1 connection when connecting the ES2-HB-N/THB-N.)
Control method		ON/OFF control or 2-PID control (with auto-tuning)
Control output	Relay output	E5CC-800/E5CC-B-800: SPST-NO, 250 VAC, 3 A (resistive load), electrical life: 100,000 operations, minimum applicable load: 5 V, 10 mA (reference value) E5CC-U-800: SPDT, 250 VAC, 3 A (resistive load), electrical life: 100,000 operations, minimum applicable load: 5 V, 10 mA (reference value)
	Voltage output (for driving SSR)	Output voltage: 12 VDC ±20% (PNP), max. load current: 21 mA, with short-circuit protection circuit
	Linear current output *1	4 to 20 mA DC/0 to 20 mA DC, load: 500 Ω max., resolution: approx. 10,000
Auxiliary output	Number of outputs	2
	Output specifications	SPST-NO relay outputs, 250 VAC, E5CC-800/E5CC-U-800 models with 2 output: 3 A (resistive load), E5CC-B-800 models with 2 outputs: 2 A (resistive load) Electrical life: 100,000 operations, Minimum applicable load: 10 mA at 5 V
Event input *1*2	Number of inputs	2 (depends on model)
	External contact input specifications	Contact input: ON: 1 kΩ max., OFF: 100 kΩ min. Non-contact input: ON: Residual voltage: 1.5 V max., OFF: Leakage current: 0.1 mA max. Current flow: Approx. 7 mA per contact
Setting method		Digital setting using front panel keys
Indication method		11-segment digital display and individual indicators Character height: PV: 15.2 mm, SV: 7.1 mm
Multi SP		Up to eight set points (SP0 to SP7) can be saved and selected using event inputs, key operations, or serial communications.
Other functions		Manual output, heating/cooling control, loop burnout alarm, SP ramp, other alarm functions, heater burnout (HB) alarm (including SSR failure (HS) alarm), 40% AT, 100% AT, MV limiter, input digital filter, self tuning, PV input shift, run/stop, protection functions, temperature status display, moving average of input value
Ambient operating temperature		-10 to 55°C (with no condensation or icing)
Ambient operating humidity		25% to 85%
Storage temperature		-25 to 65°C (with no condensation or icing)
Altitude		2,000 m max.
Recommended fuse		T2A, 250 VAC, time lag, low-breaking capacity
Installation environment		Overvoltage category II, Pollution Degree 2 (EN/IEC/UL 61010-1)

*1 There are no optional functions for the E5CC-U-800. Refer to *Model Number Legend* on page 2.

*2 There are no optional functions for the E5CC-B-800. Refer to *Model Number Legend* on page 2.

Input Ranges (Universal inputs)

● Thermocouple/Platinum Resistance Thermometer

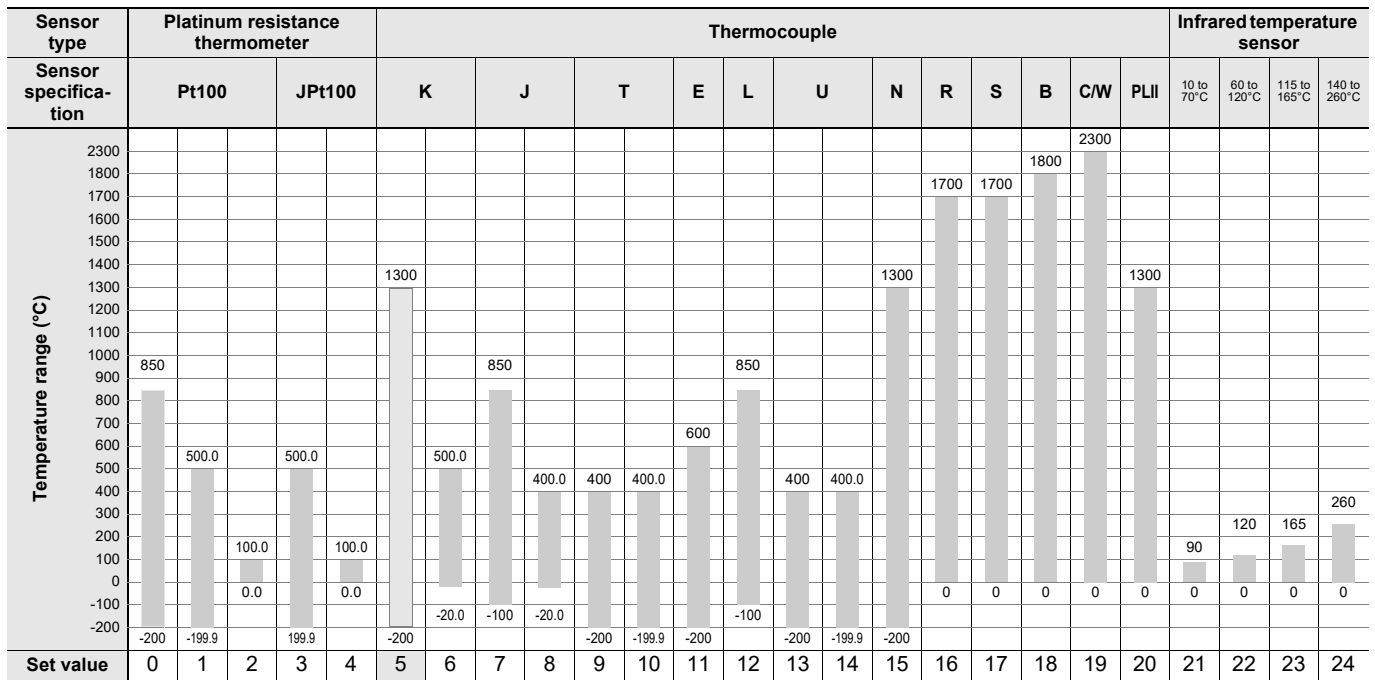

Shaded settings are the default settings.

The applicable standards for the input types are as follows:

K, J, T, E, N, R, S, B: JIS C 1602-2015, IEC 60584-1

L: Fe-CuNi, DIN 43710-1985

U: Cu-CuNi, DIN 43710-1985

C/W: W5Re/W26Re, JIS C 1602-2015, ASTM E988-1990

JPt100: JIS C 1604-1989, JIS C 1606-1989

Pt100: JIS C 1604-1997, IEC 60751

PL II: According to Platinel II electromotive force charts from BASF (previously Engelhard)

● Analog input

Input type	Current		Voltage			
Input specification	4 to 20 mA	0 to 20 mA	1 to 5 V	0 to 5 V	0 to 10 V	0 to 50 mV *
Setting range	Usable in the following ranges by scaling: -1999 to 9999, -199.9 to 999.9, -19.99 to 99.99 or -1.999 to 9.999					
Set value	25	26	27	28	29	30

* The range applies to the E5CC-U-800 only for those manufactured in May 2014 or later.











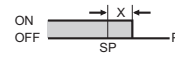

Alarm Outputs

Each alarm can be independently set to one of the following 19 alarm types. The default is 2: Upper limit. (see note.)

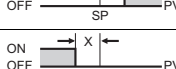
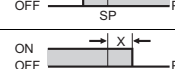
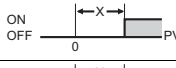
Auxiliary outputs are allocated for alarms. ON delays and OFF delays (0 to 999 s) can also be specified.

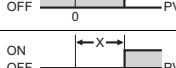
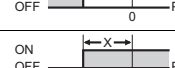
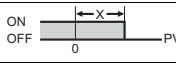
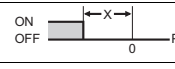
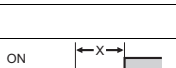
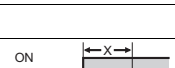
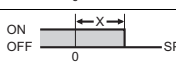
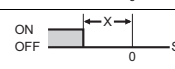
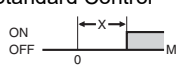
Note: In the default settings for models with HB or HS alarms, alarm 1 is set to a heater alarm (HA) and the Alarm Type 1 parameter is not displayed.

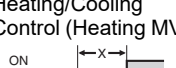
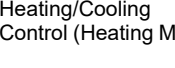
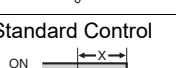
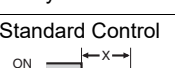
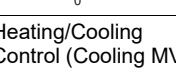
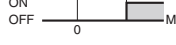
To use alarm 1, set the output assignment to alarm 1.

Set value	Alarm type	Alarm output operation		Description of function
		When alarm value X is positive	When alarm value X is negative	
0	Alarm function OFF	Output OFF		No alarm
1	Upper- and lower-limit *1		*2	Set the upward deviation in the set point for the alarm upper limit (H) and the lower deviation in the set point for the alarm lower limit (L). The alarm is ON when the PV is outside this deviation range.
2 (default)	Upper-limit			Set the upward deviation in the set point by setting the alarm value (X). The alarm is ON when the PV is higher than the SP by the deviation or more.
3	Lower-limit			Set the downward deviation in the set point by setting the alarm value (X). The alarm is ON when the PV is lower than the SP by the deviation or more.
4	Upper- and lower-limit range *1		*3	Set the upward deviation in the set point for the alarm upper limit (H) and the lower deviation in the set point for the alarm lower limit (L). The alarm is ON when the PV is inside this deviation range.
5	Upper- and lower-limit with standby sequence *1		*4	A standby sequence is added to the upper- and lower-limit alarm (1). *6
6	Upper-limit with standby sequence			A standby sequence is added to the upper-limit alarm (2). *6
7	Lower-limit with standby sequence			A standby sequence is added to the lower-limit alarm (3). *6
8	Absolute-value upper-limit			The alarm will turn ON if the process value is larger than the alarm value (X) regardless of the set point.
9	Absolute-value lower-limit			The alarm will turn ON if the process value is smaller than the alarm value (X) regardless of the set point.
10	Absolute-value upper-limit with standby sequence			A standby sequence is added to the absolute-value upper-limit alarm (8). *6
11	Absolute-value lower-limit with standby sequence			A standby sequence is added to the absolute-value lower-limit alarm (9). *6
12	LBA (alarm 1 type only)	-		*7
13	PV change rate alarm	-		*8
14	SP absolute value upper limit alarm			This alarm type turns ON the alarm when the set point (SP) is higher than the alarm value (X).
15	SP absolute value lower limit alarm			This alarm type turns ON the alarm when the set point (SP) is lower than the alarm value (X).
16	MV absolute value upper limit alarm *9	Standard Control 	Standard Control 	This alarm type turns ON the alarm when the manipulated variable (MV) is higher than the alarm value (X).
		Heating/Cooling Control (Heating MV) 	Heating/Cooling Control (Heating MV) Always ON	
17	MV absolute value lower limit alarm *9	Standard Control 	Standard Control 	This alarm type turns ON the alarm when the manipulated variable (MV) is lower than the alarm value (X).
		Heating/Cooling Control (Cooling MV) 	Heating/Cooling Control (Cooling MV) Always ON	

*1 With set values 1, 4 and 5, the upper and lower limit values can be set independently for each alarm type, and are expressed as "L" and "H."

*2 Set value: 1, Upper- and lower-limit alarm

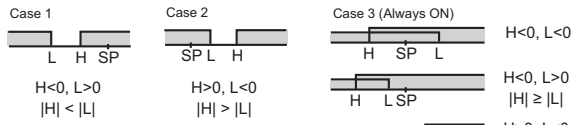

*3 Set value: 4, Upper- and lower-limit range

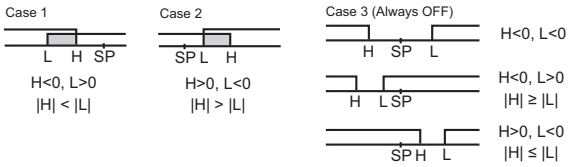

*4 Set value: 5, Upper- and lower-limit with standby sequence

For Upper- and Lower-Limit Alarm Described Above *2

• Case 1 and 2

Always OFF when the upper-limit and lower-limit hysteresis overlaps.

• Case 3: Always OFF

*5 Set value: 5, Upper- and lower-limit with standby sequence

Always OFF when the upper-limit and lower-limit hysteresis overlaps.

*6 Refer to the E5□C Digital Controllers User's Manual (Cat. No. H174) for information on the operation of the standby sequence.

*7 Refer to the E5□C Digital Controllers User's Manual (Cat. No.H174) for information on the loop burnout alarm (LBA).

*8 Refer to the E5□C Digital Controllers User's Manual (Cat. No. H174) for information on the PV change rate alarm.

*9 When heating/cooling control is performed, the MV absolute upper limit alarm functions only for the heating operation and the MV absolute lower limit alarm functions only for the cooling operation.

Characteristics

Indication accuracy (at the ambient temperature of 23°C)	E5CC-800/E5CC-B-800	
	Thermocouple: ($\pm 0.3\%$ of indication value or $\pm 1^\circ\text{C}$, whichever is greater) ± 1 digit max. *1 Platinum resistance thermometer: ($\pm 0.2\%$ of indication value or $\pm 0.8^\circ\text{C}$, whichever is greater) ± 1 digit max. Analog input: $\pm 0.2\%$ FS ± 1 digit max. CT input: $\pm 5\%$ FS ± 1 digit max.	
Simple transfer output accuracy	E5CC-U-800	
	Thermocouple: ($\pm 1\%$ of indication value or $\pm 2^\circ\text{C}$, whichever is greater) ± 1 digit max. *1 Platinum resistance thermometer: ($\pm 0.2\%$ of indication value or $\pm 0.8^\circ\text{C}$, whichever is greater) ± 1 digit max. Analog input: $\pm 0.2\%$ FS ± 1 digit max.	
Influence of temperature *3	$\pm 0.3\%$ FS max.*2	
Influence of voltage *3	Thermocouple input (R, S, B, C/W, PL II): ($\pm 1\%$ of indication value or $\pm 10^\circ\text{C}$, whichever is greater) ± 1 digit max. Other thermocouple input: ($\pm 1\%$ of indication value or $\pm 4^\circ\text{C}$, whichever is greater) ± 1 digit max. *4 Platinum resistance thermometer: ($\pm 1\%$ of indication value or $\pm 2^\circ\text{C}$, whichever is greater) ± 1 digit max. Analog input: $\pm 1\%$ FS ± 1 digit max.	
Influence of EMS. (at EN 61326-1)	CT input: $\pm 5\%$ FS ± 1 digit max.	
Input sampling period	50 ms	
Hysteresis	Temperature input: 0.1 to 999.9°C or °F (in units of 0.1°C or °F) Analog input: 0.01% to 99.99% FS (in units of 0.01% FS)	
Proportional band (P)	Temperature input: 0.1 to 999.9°C or °F (in units of 0.1°C or °F) Analog input: 0.1% to 999.9% FS (in units of 0.1% FS)	
Integral time (I)	0 to 9999 s (in units of 1 s), 0.0 to 999.9 s (in units of 0.1 s) *5	
Derivative time (D)	0 to 9999 s (in units of 1 s), 0.0 to 999.9 s (in units of 0.1 s) *5	
Proportional band (P) for cooling	Temperature input: 0.1 to 999.9°C or °F (in units of 0.1°C or °F) Analog input: 0.1% to 999.9% FS (in units of 0.1% FS)	
Integral time (I) for cooling	0 to 9999 s (in units of 1 s), 0.0 to 999.9 s (in units of 0.1 s) *5	
Derivative time (D) for cooling	0 to 9999 s (in units of 1 s), 0.0 to 999.9 s (in units of 0.1 s) *5	
Control period	0.1, 0.2, 0.5, 1 to 99 s (in units of 1 s)	
Manual reset value	0.0 to 100.0% (in units of 0.1%)	
Alarm setting range	-1999 to 9999 (decimal point position depends on input type)	
Affect of signal source resistance	Thermocouple: 0.1°C/ Ω max. (100 Ω max.) Platinum resistance thermometer: 0.1°C/ Ω max. (10 Ω max.)	
Insulation resistance	20 M Ω min. (at 500 VDC)	
Dielectric strength	3,000 VAC, 50/60 Hz for 1 min between terminals of different charge	
Vibration	Malfunction	10 to 55 Hz, 20 m/s ² for 10 min each in X, Y, and Z directions
	Resistance	10 to 55 Hz, 20 m/s ² for 2 hrs each in X, Y, and Z directions
Shock	Malfunction	100 m/s ² , 3 times each in X, Y, and Z directions
	Resistance	300 m/s ² , 3 times each in X, Y, and Z directions
Weight	E5CC-800/E5CC-B-800: Controller: Approx. 120 g, Adapter: Approx. 10 g E5CC-U-800: Controller: Approx. 100 g, Adapter: Approx. 10 g	
Degree of protection	E5CC-800/E5CC-B-800: Front panel: IP66, Rear case: IP20, Terminals: IP00 E5CC-U-800: Front panel: IP50, Rear case: IP20, Terminals: IP00	
Memory protection	Non-volatile memory (number of writes: 1,000,000 times)	
Standards	Approved standards	cULus: UL 61010-1/CSA C22.2 No.61010-1 *6, Korean wireless regulations (Radio law: KC Mark) (Some models only.) *7, Lloyd's standards *8
	Conformed standards	EN 61010-1 (IEC 61010-1), RCM
EMC	EMI:	EN 61326-1 *9
	Radiated Interference Electromagnetic Field Strength:	EN 55011 Group 1, class A
	Noise Terminal Voltage:	EN 55011 Group 1, class A
	EMS:	EN 61326-1 *9
	ESD Immunity:	EN 61000-4-2
	Electromagnetic Field Immunity:	EN 61000-4-3
	Burst Noise Immunity:	EN 61000-4-4
	Conducted Disturbance Immunity:	EN 61000-4-6
Surge Immunity:	EN 61000-4-5	
Voltage Dip/Interrupting Immunity:	EN 61000-4-11	

*1 The indication accuracy of K thermocouples in the -200 to 1300°C range, T and N thermocouples at a temperature of -100°C max., and U and L thermocouples at any temperatures is $\pm 2^\circ\text{C} \pm 1$ digit max. The indication accuracy of the B thermocouple at a temperature of 400°C max. is not specified. The indication accuracy of B thermocouples at a temperature of 400 to 800° is $\pm 3^\circ\text{C}$ max. The indication accuracy of the R and S thermocouples at a temperature of 200°C max. is $\pm 3^\circ\text{C} \pm 1$ digit max. The indication accuracy of C/W thermocouples is ($\pm 0.3\%$ of PV or $\pm 3^\circ\text{C}$, whichever is greater) ± 1 digit max. The indication accuracy of PL II thermocouples is $\pm 0.3\%$ of PV or $\pm 2^\circ\text{C}$, whichever is greater, ± 1 digit max.

*2 However, the precision between 0 and 4 mA for a 0 to 20 mA output is $\pm 1\%$ FS max.

*3 Ambient temperature: -10°C to 23°C to 55°C, Voltage range: -15% to 10% of rated voltage

*4 K thermocouple at -100°C max.: $\pm 10^\circ\text{C}$ max.

*5 The unit is determined by the setting of the Integral/Derivative Time Unit parameter.

*6 The E5CC-U plug-in model is certified for UL listing only when used together with the OMRON P2CF-11 or P2CF-11-E Socket. The P3GA-11 is not certified for UL listing.

*7 Access the following website for information on certified models. <http://www.ia.omron.com/support/models/index.html>

*8 Refer to information on maritime standards in *Shipping Standards* on page 65 for compliance with Lloyd's Standards.

*9 Industrial electromagnetic environment (EN/IEC 61326-1 Table 2)

Communications Specifications

Transmission line connection method	RS-485: Multidrop
Communications	RS-485 (two-wire, half duplex)
Synchronization method	Start-stop synchronization
Protocol	CompoWay/F, or Modbus
Baud rate *1	9600, 19200, 38400, or 57600 bps
Transmission code	ASCII
Data bit length *1	7 or 8 bits
Stop bit length *1	1 or 2 bits
Error detection	Vertical parity (none, even, odd) Block check character (BCC) with CompoWay/F or CRC-16 with Modbus *2
Flow control	None
Interface	RS-485
Retry function	None
Communications buffer	217 bytes
Communications response wait time	0 to 99 ms Default: 20 ms

*1 The baud rate, data bit length, stop bit length, and vertical parity can be individually set using the Communications Setting Level.

*2 Modbus is a registered trademark of Schneider Electric.

Communications Functions

Programless communications*1	You can use the memory in the PLC to read and write E5□C parameters, start and stop operation, etc. The E5□C automatically performs communications with PLCs. No communications programming is required. Number of connected Temperature Controllers: 32 max. (Up to 16 for the FX Series) Applicable PLCs OMRON PLCs CS Series, CJ Series, CP Series, NJ Series, or NX1P Mitsubishi Electric PLCs MELSEC Q Series, L Series, FX3 Series, or iQ-R Series KEYENCE PLCs KEYENCE KV Series
Component Communications*1	When Digital Temperature Controllers are connected, set points and RUN/STOP commands can be sent from the Digital Temperature Controller that is set as the master to the Digital Temperature Controllers that are set as slaves. Slope and offsets can be set for the set point. Number of connected Digital Temperature Controllers: 32 max. (including master)
Copying*2	When Digital Temperature Controllers are connected, the parameters can be copied from the Digital Temperature Controller that is set as the master to the Digital Temperature Controllers that are set as slaves.

MELSEC is a registered trademark of Mitsubishi Electric Corporation.
KEYENCE is a registered trademark of Keyence Corporation.

*1 A Temperature Controller with version 1.1 or higher is required.
A Temperature Controller with version 2.1 or higher is required for the FX Series or the KV Series.

*2 Both the programless communications and the component communications support the copying.

Current Transformer (Order Separately) Ratings

	E54-CT1 E54-CT3	E54-CT1L E54-CT3L
Dielectric strength	1,000 VAC for 1 min	1,500 VAC for 1 min
Vibration resistance	50 Hz, 98 m/s ²	
Weight	E54-CT1: Approx. 11.5 g, E54-CT3: Approx. 50 g	E54-CT1: Approx. 14 g, E54-CT3: Approx. 57 g
Accessories	E54-CT3 Only Armatures (2) Plugs (2)	None

Heater Burnout Alarms and SSR Failure Alarms

CT input (for heater current detection)	Models with detection for single-phase heaters: One input
Maximum heater current	50 A AC
Input current indication accuracy	±5% FS ±1 digit max.
Heater burnout alarm setting range *1	0.1 to 49.9 A (in units of 0.1 A) Minimum detection ON time: 100 ms *3
SSR failure alarm setting range *2	0.1 to 49.9 A (in units of 0.1 A) Minimum detection OFF time: 100 ms *4

*1 For heater burnout alarms, the heater current will be measured when the control output is ON, and the output will turn ON if the heater current is lower than the set value (i.e., heater burnout detection current value).

*2 For SSR failure alarms, the heater current will be measured when the control output is OFF, and the output will turn ON if the heater current is higher than the set value (i.e., SSR failure detection current value).

*3 The value is 30 ms for a control period of 0.1 s or 0.2 s.

*4 The value is 35 ms for a control period of 0.1 s or 0.2 s.

Electrical Life Expectancy Curve for Control output Relays (Reference Values)

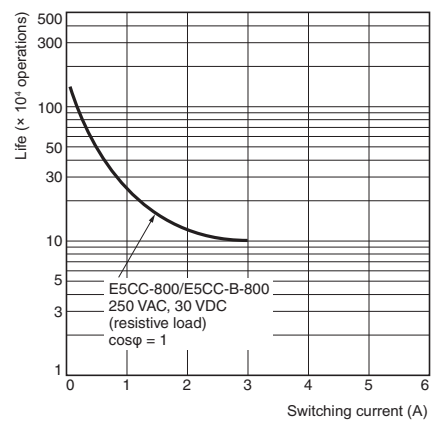

E5CC-800/E5CC-B-800/E5CC-U-800

External Connections

E5CC-800 (Screw Terminal Blocks)

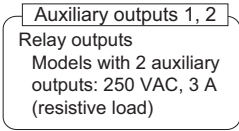
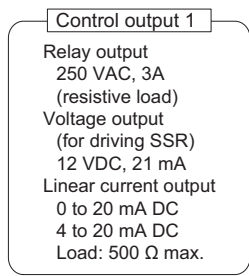

E5CC-□□ 2 □ S M - 8□□
(1) (2) (3) (4) (5) (6)
↑
Terminal type

The E5CC-800 is set for a K-type thermocouple (input type = 5) by default. An input error (5.ERR) will occur if the input type setting does not agree with the temperature sensor. Check the input type.

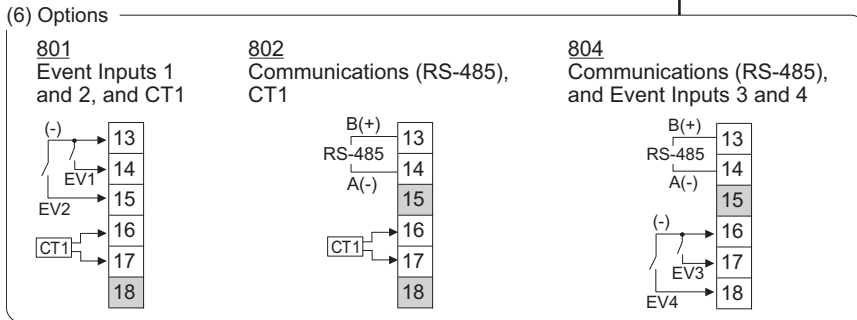
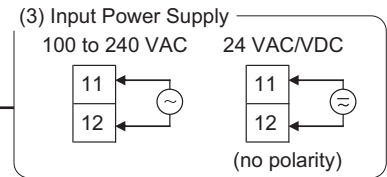
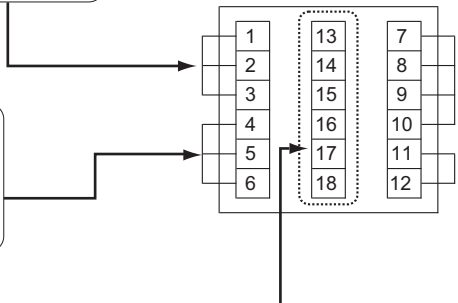
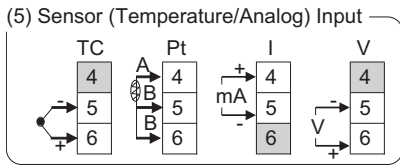
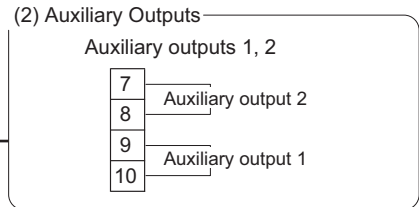
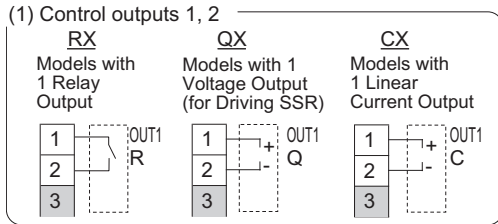

Use no-voltage inputs for the event inputs.
The polarity for non-contact inputs is given in parentheses.

- Note:**
- The application of the terminals depends on the model.
 - Do not wire the terminals that are shown with a gray background.
 - When complying with EMC standards, the cable that connects the sensor must be 30 m or less. If the cable length exceeds 30 m, compliance with EMC standards will not be possible.
 - Connect M3 crimped terminals.
 - Due to UL Listing requirements, use the E54-CT1L or E54-CT3L Current Transformer with the factory wiring (internal wiring). Use a UL category XOBA or XOBA7 current transformer that is UL Listed for field wiring (external wiring) and not the factory wiring (internal wiring).

E5CC-B-800 (Push-In Plus Terminal Blocks)

E5CC-□□ 2 □ B M - 8□□
 (1) (2) (3) (4) (5) (6)

Terminal type

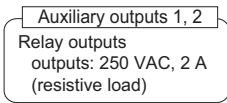
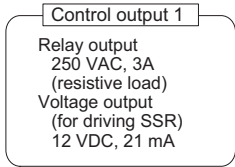

The E5CC is set for a K-type thermocouple (input type = 5) by default. An input error (5ERR) will occur if the input type setting does not agree with the temperature sensor. Check the input type.

(1) Control outputs 1

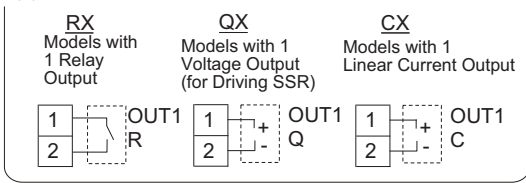

(5) Sensor (Temperature/Analog) Input

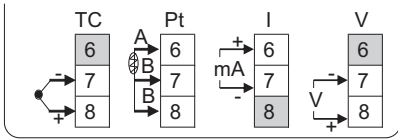

(6) Options

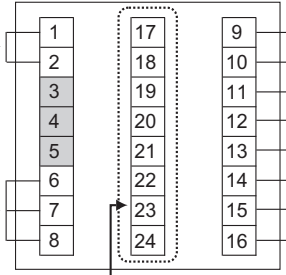
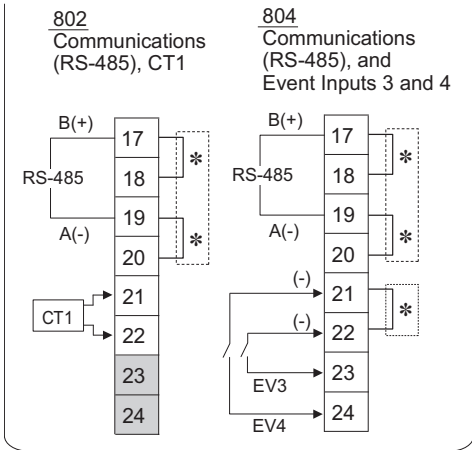

(2) Auxiliary Outputs

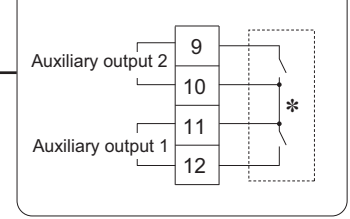

(3) Input Power Supply
100 to 240 VAC

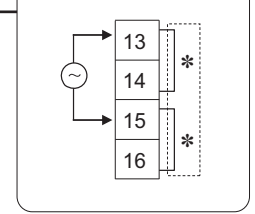

Note: 1. The application of the terminals depends on the model.

2. Do not wire the terminals that are shown with a gray background.
3. When complying with EMC standards, the cable that connects the sensor must be 30 m or less. If the cable length exceeds 30 m, compliance with EMC standards will not be possible.
4. Refer to *Wiring Precautions for E5□C-B (Controllers with Push-In Plus Terminal Blocks)* on page 71 for wire specifications and wiring methods.
5. Common terminals are indicated with asterisks (*). You can use the input power supply and communications common terminals for crossover wiring. Do not exceed the maximum number of Temperature Controllers given below if you use crossover wiring for the input power supply.
100 to 240 VAC Controllers: 16 max.

Wiring Example:

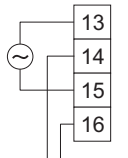

To another E5□C

6. Due to UL Listing requirements, use the E54-CT1L or E54-CT3L Current Transformer with the factory wiring (internal wiring). Use a UL category XOBA or XOBA7 current transformer that is UL Listed for field wiring (external wiring) and not the factory wiring (internal wiring).

E5CC-800/E5CC-B-800/E5CC-U-800

E5CC-U-800

The E5CC-U is set for a K-type thermocouple (input type = 5) by default. An input error (5.ERR) will occur if the input type setting does not agree with the temperature sensor. Check the input type.

E5CC-□□□□UM-800

Control output 1

Auxiliary outputs 1 and 2

Relay output
250 VAC, 3 A (resistive load)

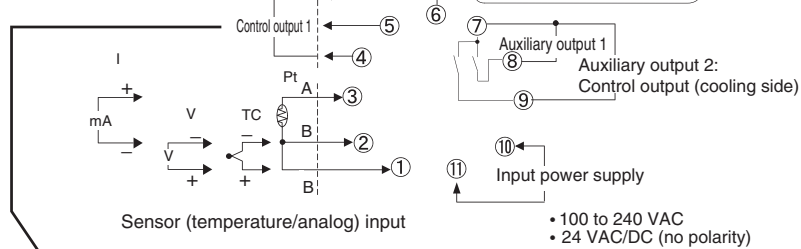

• 100 to 240 VAC
• 24 VAC/DC (no polarity)

Control output 1

Voltage output (for driving SSR)
12 VDC, 21 mA
Relay output (three terminals used)
SPDT, 250 VAC, 3 A
(resistive load)

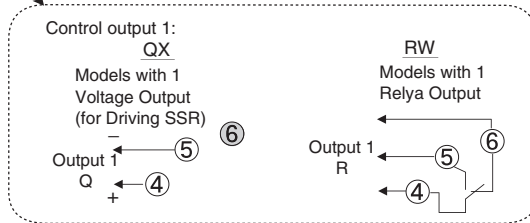

- Note:**
1. The application of the terminals depends on the model.
 2. Do not wire the terminals that are shown with a gray background.
 3. When complying with EMC standards, the cable that connects the sensor must be 30 m or less. If the cable length exceeds 30 m, compliance with EMC standards will not be possible.
 4. Connect M3.5 crimped terminals for the E5CC-U-800.

Isolation/Insulation Block Diagrams

• E5CC-800

Models with 2 Auxiliary Outputs

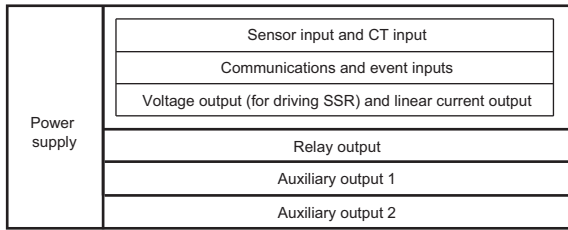

: Reinforced insulation
 : Functional isolation

• E5CC-U-800

Models with 2 Auxiliary Outputs

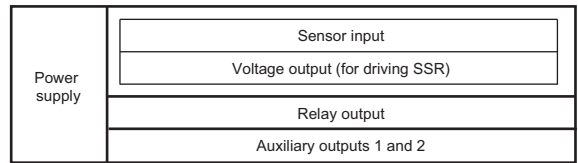

: Reinforced insulation
 : Functional isolation

• E5CC-B-800

Models with 2 Auxiliary Outputs

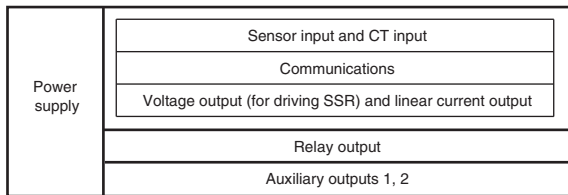

: Reinforced insulation
 : Functional isolation

Nomenclature

**E5CC-800
 E5CC-B-800
 E5CC-U-800**

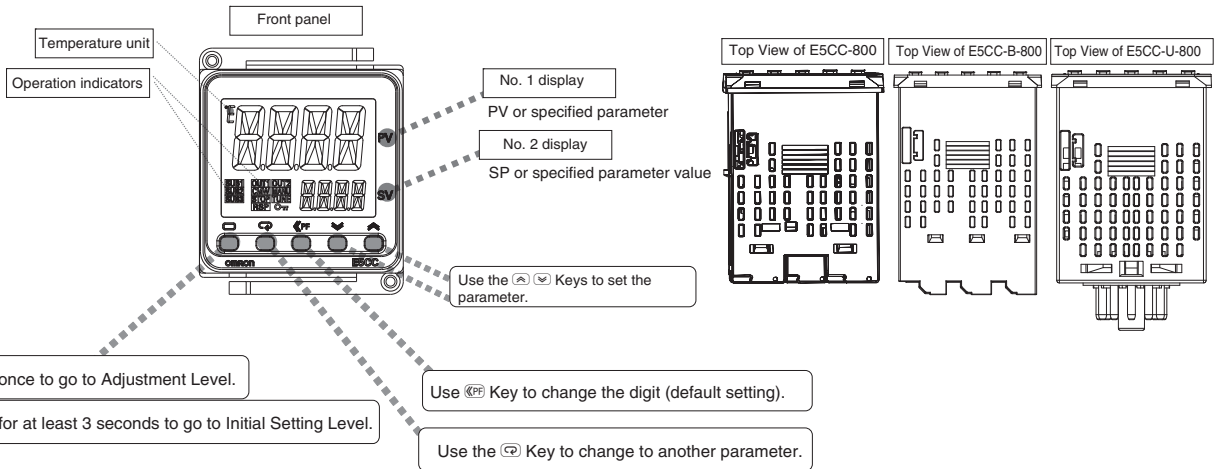

E5CC-800/E5CC-B-800/E5CC-U-800

Dimensions

(Unit: mm)

Controllers

E5CC-800

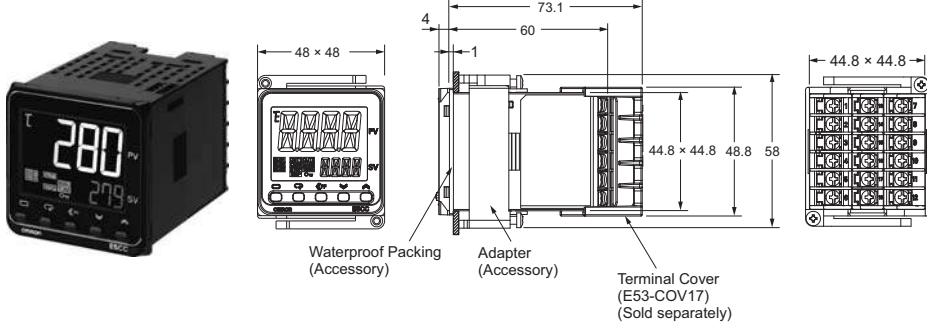

E5CC-B-800

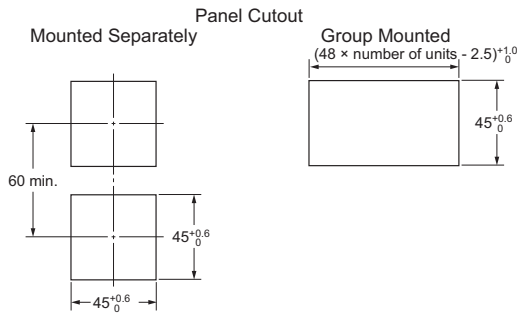
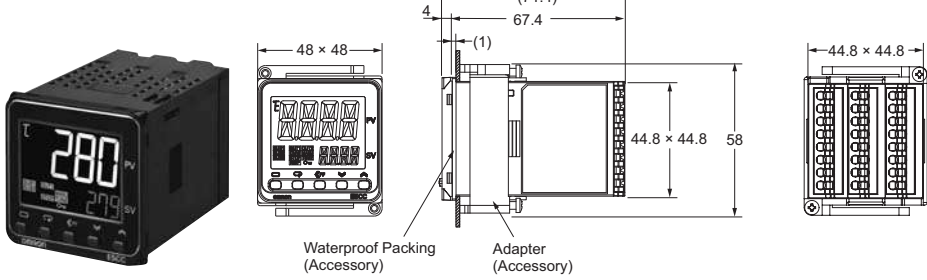

- Recommended panel thickness is 1 to 5 mm.
- Group mounting is not possible in the vertical direction. (Maintain the specified mounting space between Controllers.)
- To mount the Controller so that it is waterproof, insert the waterproof packing onto the Controller.
- When two or more Controllers are mounted, make sure that the surrounding temperature does not exceed the allowable operating temperature specified in the specifications.

E5CC-U-800

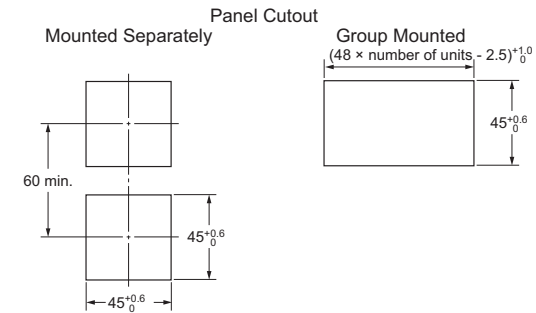
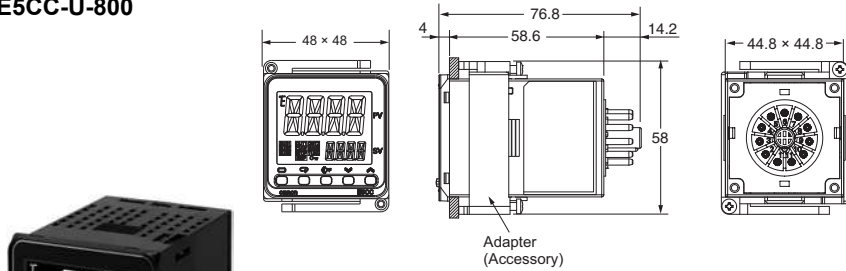

- Recommended panel thickness is 1 to 5 mm.
- Group mounting is not possible in the vertical direction. (Maintain the specified mounting space between Controllers.)
- When two or more Controllers are mounted, make sure that the surrounding temperature does not exceed the allowable operating temperature specified in the specifications.

Accessories (Order Separately)

● Terminal Covers
E53-COV17

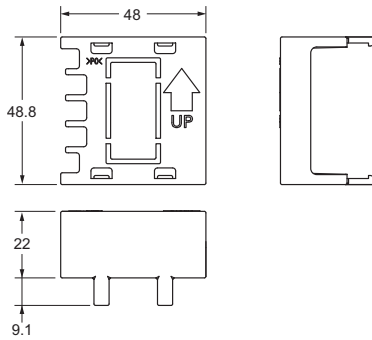
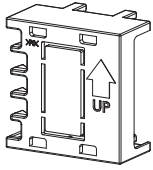

● Terminal Covers
E53-COV23 (Three Covers provided.)

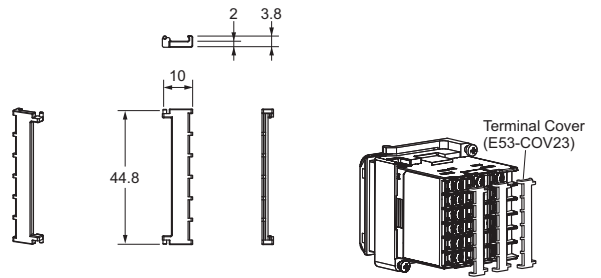

● Terminal Cover (for the P3GA-11 Back-connecting Socket)
Y92A-48G

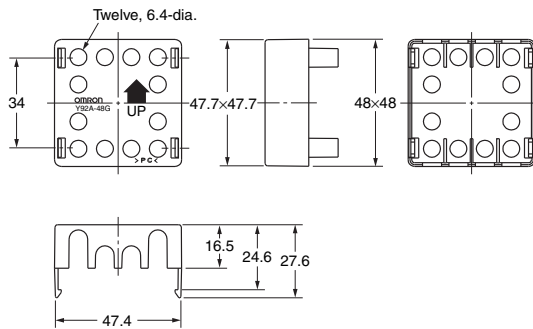
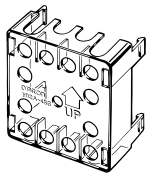

Note: You can attach the P3GA-11 Back-connecting Socket for finger protection.

● Waterproof Packing
Y92S-P8 (for DIN 48 × 48)

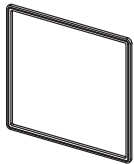

The Waterproof Packing is provided only with the E5CC-800/E5CC-B-800. It is not included with the E5CC-U-800. Order the Waterproof Packing separately if it becomes lost or damaged. The Waterproof Packing can be used to achieve an IP66 degree of protection. (Deterioration, shrinking, or hardening of the waterproof packing may occur depending on the operating environment. Therefore, periodic replacement is recommended to ensure the level of waterproofing specified in IP66. The time for periodic replacement depends on the operating environment. Be sure to confirm this point at your site. Consider three years as a rough standard.) The E5CC-U-800 cannot be waterproofed even if the Waterproof Packing is attached.

E5CC-800/E5CC-B-800/E5CC-U-800

● Adapter

Y92F-45

- Note:** 1. Use this Adapter when the Front Panel has already been prepared for the E5B□.
2. Only black is available.

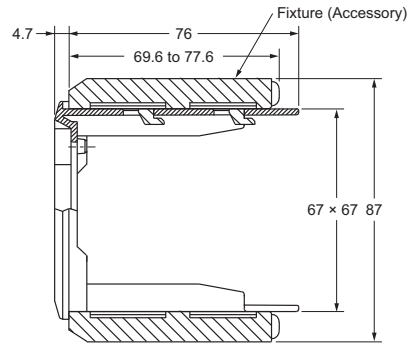
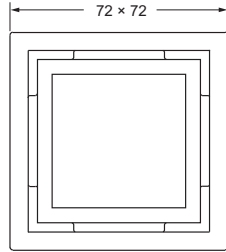
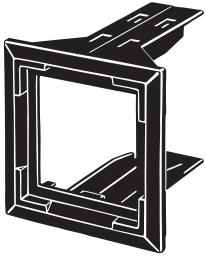

Mounted to E5CC-800

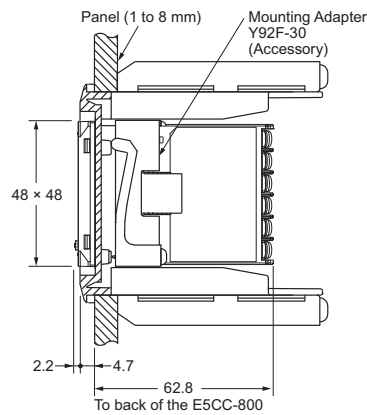
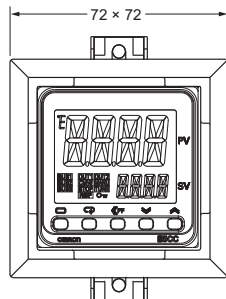
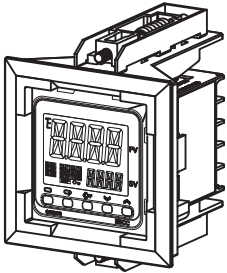

● DIN Track Mounting Adapter

Y92F-52

- Note:** 1. This Adapter cannot be used together with the Terminal Cover. Remove the Terminal Cover to use the Adapter.
2. This Adapter cannot be used with the E5CC-B-800.

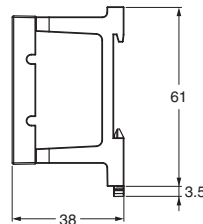
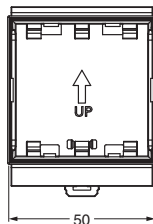
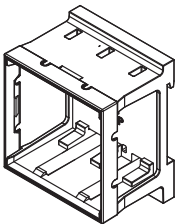

This Adapter is used to mount the E5CC-800 to a DIN Track. If you use the Adapter, there is no need for a plate to mount in the panel or to drill mounting holes in the panel.

Mounted to E5CC-800

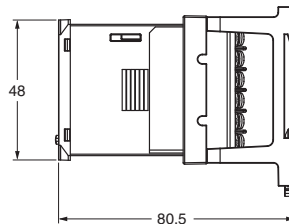
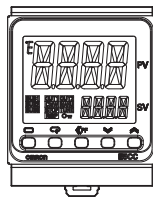
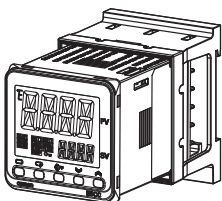

● **Watertight Cover**
Y92A-48N

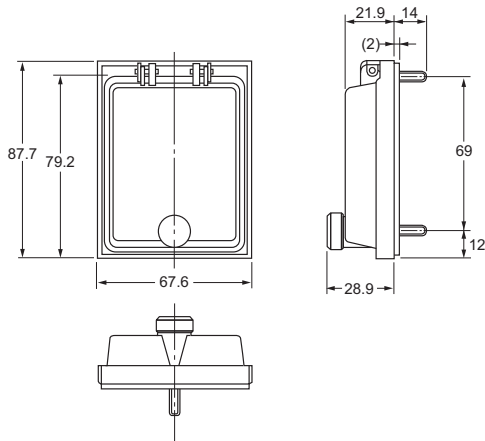

● **Mounting Adapter**
Y92F-49

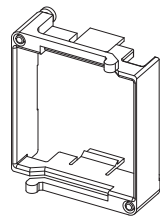

The Mounting Adapter is provided with the Temperature Controller. Order this Adapter separately if it becomes lost or damaged.

● **Protective Cover**
Y92A-48D

Note: This Protective Cover cannot be used if the Waterproof Packing is installed.

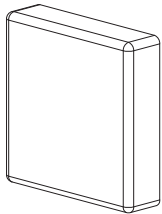

This Protective Cover is soft type. It is able to operate the controller with using this cover.

● **Protective Cover**
Y92A-48H

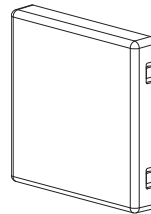

This Protective Cover is hard type. Please use it for the mis-operation prevention etc.

● **E5CC-U-800 Wiring Socket**

Front-connecting Socket
P2CF-11

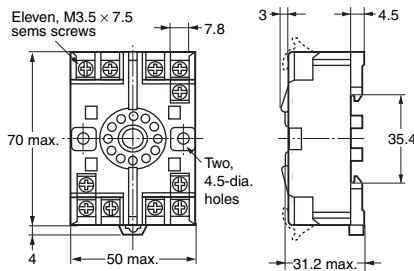
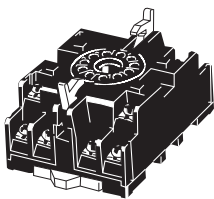

Terminal Layout/Internal Connections
(Top View)

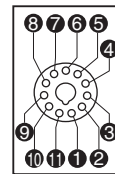

Mounting Holes

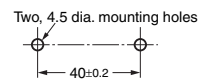

Note: Can also be mounted to a DIN track

Note: 1. A model with finger protection (P2CF-11-E) is also available.
2. You cannot use the P2CF-11 or P2CF-11-E together with the Y92F-45.

Back-connecting Socket
P3GA-11

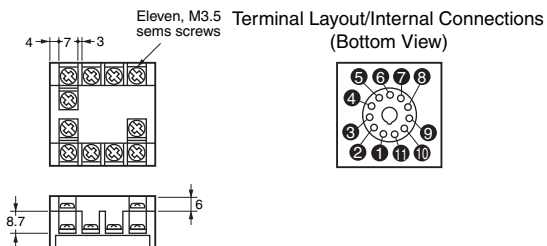
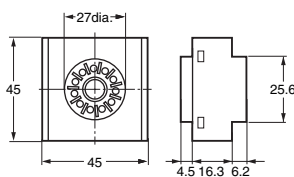
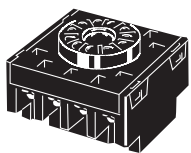

Terminal Layout/Internal Connections
(Bottom View)

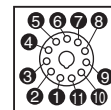

Note: 1. Using any other sockets will adversely affect accuracy. Use only the specified sockets.
2. A Protective Cover for finger protection (Y92A-48G) is also available.
3. You cannot use the P3GA-11 together with the Y92F-45.

E5CC-800/E5CC-B-800/E5CC-U-800

● Current Transformers

E54-CT1

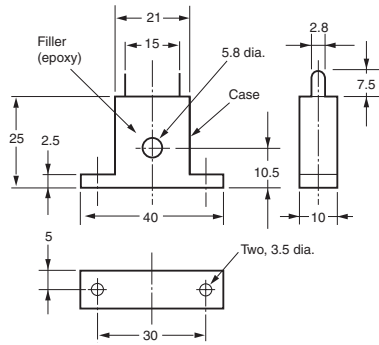
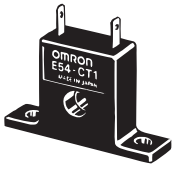

Thru-current (I_o) vs. Output Voltage (E_o) (Reference Values)

E54-CT1 or E54-CT1L

Maximum continuous heater current: 50 A (50/60 Hz)
 Number of windings: 400±2
 Winding resistance: 18±2 Ω

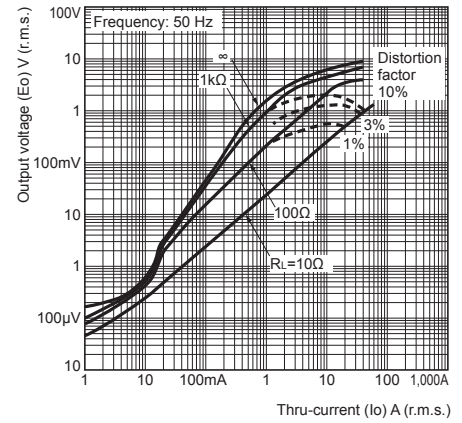

E54-CT1L

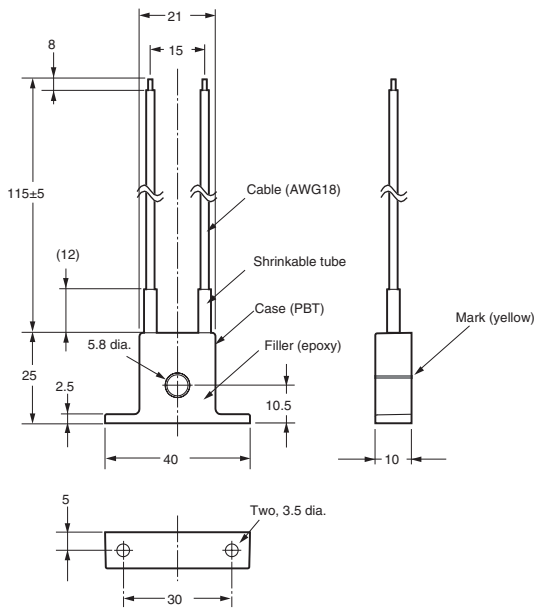
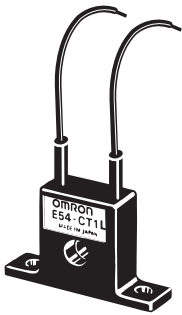

E54-CT3

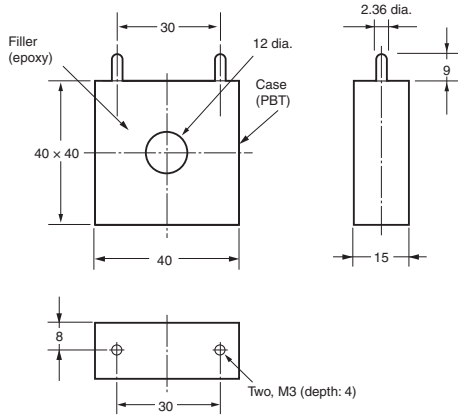

E54-CT3 Accessories

• **Armature**

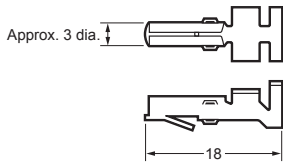

Connection Example

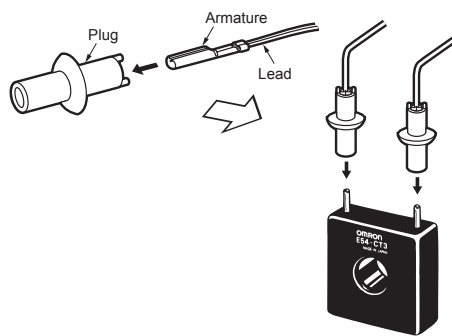

• **Plug**

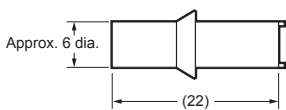

**Thru-current (Io) vs. Output Voltage (Eo)
(Reference Values)**

E54-CT3 or E54-CT3L

Maximum continuous heater current: 120 A (50/60 Hz)

(Maximum continuous heater current for an OMRON Digital Temperature Controller is 50 A.)

Number of windings: 400±2

Winding resistance: 8±0.8 Ω

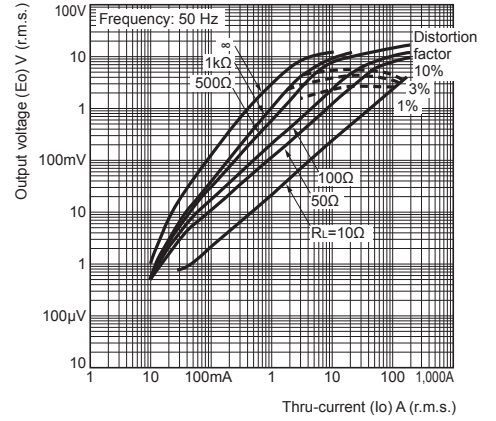

E54-CT3L

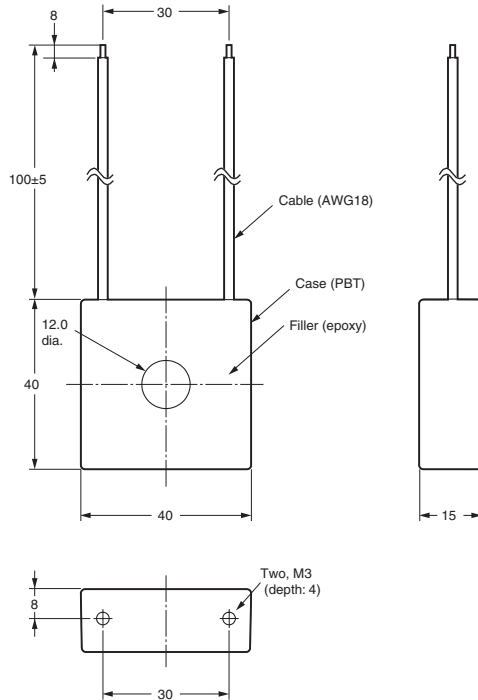

E5EC-800/E5EC-B-800/E5AC-800 (48 × 96 mm/96 × 96 mm)

Large White PV Display That's Easier to Read.

Easy to Use, from Model Selection to Setup and Operation.

Models with Push-In Plus Terminal Blocks Added to 48 × 96-mm Lineup.



* CSA conformance evaluation by UL.



48 × 96 mm
Screw Terminal
Blocks
E5EC-800

48 × 96 mm
Push-In Plus
Terminal
Blocks
E5EC-B-800

96 × 96 mm
Screw Terminal Blocks
E5AC-800

Refer to your OMRON website for the most recent information on applicable safety standards.

Refer to Safety Precautions on page 62.

- A white LCD PV display with a height of approx. 18 mm for the E5EC/E5EC-B-800 and 25 mm for the E5AC-800 improves visibility.
- High-speed sampling at 50 ms.
- With 48 x 96-mm Controllers, you can select between screw terminal blocks or Push-In Plus terminal blocks to save wiring work.
- Short body with depth of only 60 mm. (Screw Terminal Blocks)
- Easy connections to a PLC with programless communications. Use component communications to link Temperature Controllers to each other.

Main I/O Functions

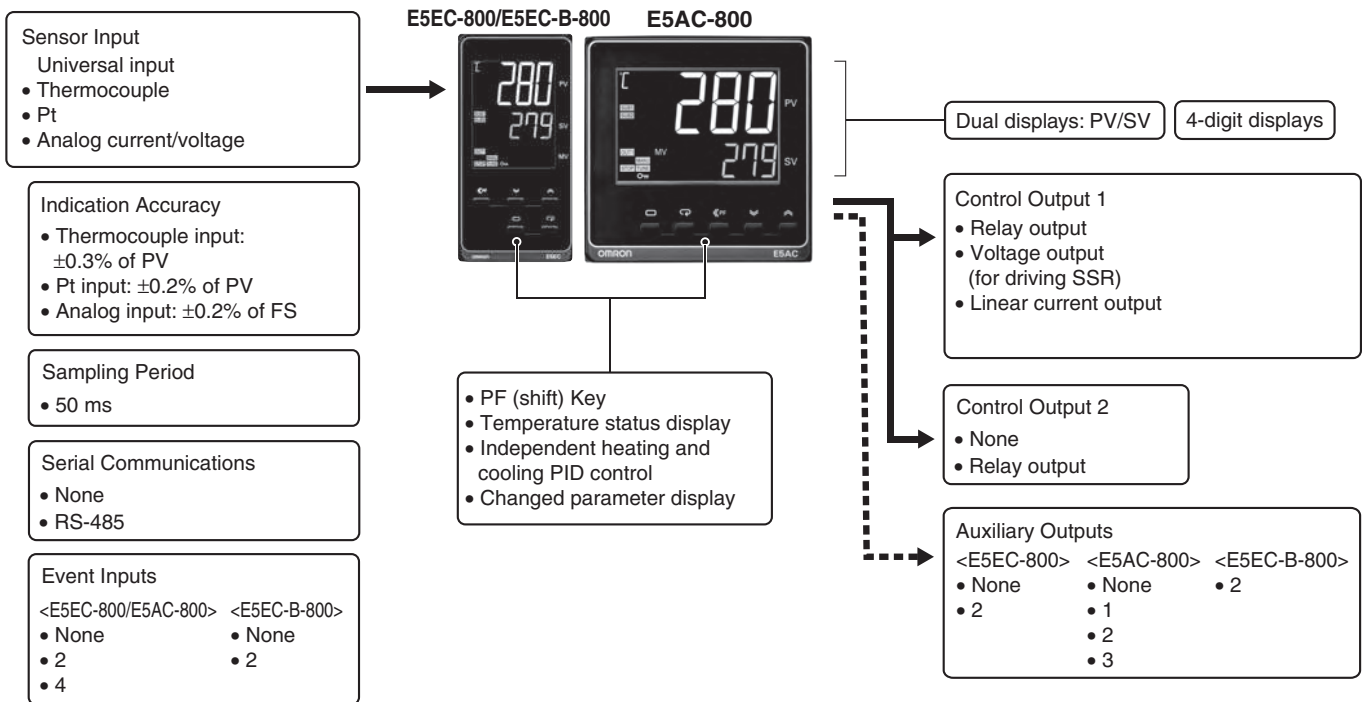

E5EC-800/E5EC-B-800/E5AC-800

Model Number Legend and Standard Models

Model Number Legend

● Models with Screw Terminal Blocks

E5EC-800 48 × 96 mm

Control output 1	Control output 2	Auxiliary output	Communications	Heater burnout	Event inputs	Power supply voltage	Model							
Relay output	-	Two	-	-	-	100 to 240 VAC	E5EC-RX2ASM-800							
Voltage output	-						E5EC-QX2ASM-800							
Linear current output	-						E5EC-CX2ASM-800							
Relay output	Relay output						E5EC-RR2ASM-800							
Voltage output	Relay output						E5EC-QR2ASM-800							
Linear current output	Relay output						E5EC-CR2ASM-800							
Relay output	-					24 VAC/VDC	-	-	-	E5EC-RX2DSM-800				
Voltage output	-									E5EC-QX2DSM-800				
Linear current output	-									E5EC-CX2DSM-800				
Relay output	Relay output									E5EC-RR2DSM-800				
Voltage output	Relay output									E5EC-QR2DSM-800				
Linear current output	Relay output									E5EC-CR2DSM-800				
Relay output	Relay output		RS-485	-	-	Two				E5EC-RR2ASM-808				
Voltage output	Relay output									E5EC-RR2DSM-808				
Relay output	Relay output									E5EC-QR2DSM-808				
Voltage output	Relay output									-	-	-	Four	E5EC-RR2ASM-810
Relay output	Relay output													E5EC-QR2ASM-810
Voltage output	Relay output													E5EC-RR2DSM-810
Relay output	Relay output		E5EC-QR2DSM-810											
Voltage output	Relay output		RS-485	-	-	Two	E5EC-CR2ASM-804							
Linear current output	Relay output						E5EC-CR2DSM-804							
Relay output (Open)*	Relay output (Close)*						-	-	-	-	E5EC-PR0ASM-800			
Relay output (Open)*	Relay output (Close)*										Two	-	-	E5EC-PR2ASM-800
Relay output (Open)*	Relay output (Close)*													E5EC-PR2ASM-804

* Position proportional control model.

Note: Draw-out-type models of the E5EC-800 are available. Ask your OMRON representative for details.

● Models with Push-In Plus Terminal Blocks

E5EC-B-800 48 × 96 mm

Control output 1	Control output 2	Auxiliary output	Communications	Heater burnout	Event inputs	Power supply voltage	Model
Relay output	-	Two	-	-	-	100 to 240 VAC	E5EC-RX2ABM-800
Voltage output	-						E5EC-QX2ABM-800
Linear current output	-						E5EC-CX2ABM-800
Relay output	Relay output						E5EC-RR2ABM-800
Voltage output	Relay output						E5EC-QR2ABM-800
Linear current output	-						E5EC-CX2ABM-804
Relay output	Relay output		RS-485	-	-	Two	E5EC-RR2ABM-808
Voltage output	Relay output						E5EC-QR2ABM-808

E5AC-800 48 × 96 mm

Control output 1	Control output 2	Auxiliary output	Communications	Heater burnout	Event inputs	Power supply voltage	Model			
Relay output	-	One	-	-	-	100 to 240 VAC	E5AC-RX1ASM-800			
Voltage output	-						E5AC-QX1ASM-800			
Linear current output	-						E5AC-CX1ASM-800			
Relay output	-	Three					E5AC-RX3ASM-800			
Voltage output	-						E5AC-QX3ASM-800			
Linear current output	-						E5AC-CX3ASM-800			
Relay output	-	One				24 VAC/VDC	-	-	E5AC-RX1DSM-800	
Voltage output	-								E5AC-QX1DSM-800	
Linear current output	-								E5AC-CX1DSM-800	
Relay output	-	Three							E5AC-RX3DSM-800	
Voltage output	-								E5AC-QX3DSM-800	
Linear current output	-								E5AC-CX3DSM-800	
Relay output	-	Three	RS-485	One	Two	100 to 240 VAC	E5AC-RX3ASM-808			
Voltage output	-					E5AC-QX3ASM-808				
Relay output	-					24 VAC/VDC	E5AC-RX3DSM-808			
Voltage output	-						E5AC-QX3DSM-808			
Linear current output	-						-	Four	100 to 240 VAC	E5AC-RX3ASM-810
Relay output	-					E5AC-QX3ASM-810				
Voltage output	-		24 VAC/VDC		E5AC-RX3DSM-810					
Relay output	-				E5AC-QX3DSM-810					
Voltage output	-				RS-485	Two			100 to 240 VAC	E5AC-CX3ASM-804
Linear current output	-		E5AC-CX3DSM-804							
Relay output (Open)*	Relay output (Close)*		-				-	-	100 to 240 VAC	E5AC-PR0ASM-800
Relay output (Open)*	Relay output (Close)*									Two
Relay output (Open)*	Relay output (Close)*	RS-485		Two						

* Position proportional control model.

Note: Draw-out-type models of the E5AC-800 are available. Ask your OMRON representative for details.

Heating and Cooling Control

●Using Heating and Cooling Control

(1) Control Output Assignment

If there is no control output 2, an auxiliary output is used as the cooling control output.

If there is a control output 2, the two control outputs are used for heating and cooling.

(It does not matter which output is used for heating and which output is used for cooling.)

(2) Control

If PID control is used, you can set PID control separately for heating and cooling.

This allows you to handle control systems with different heating and cooling response characteristics.

Optional Products (Order Separately)

Terminal Covers (for E5EC-800/E5AC-800)

Model
E53-COV24 (3pcs)

Waterproof Packing

Applicable Controller	Model
E5EC-800/ E5EC-B-800	Y92S-P9
E5AC-800	Y92S-P10

Note: This Waterproof Packing is provided with the Digital Temperature Controller.

Waterproof Cover

Applicable Controller	Model
E5EC-800/ E5EC-B-800	Y92A-49N
E5AC-800	Y92A-96N

Mounting Adapter

Model
Y92F-51

(Two Adapters are included.)

Note: This Mounting Adapter is provided with the Digital Temperature Controller.

Current Transformers (CTs)

Hole diameter	Model
5.8 mm	E54-CT1
5.8 mm	E54-CT1L *
12.0 mm	E54-CT3
12.0 mm	E54-CT3L *

* Lead wires are included with these CTs. If UL certification is required, use these CTs.

Specifications

Ratings

Power supply voltage		A in model number: 100 to 240 VAC, 50/60 Hz D in model number: 24 VAC, 50/60 Hz; 24 VDC
Operating voltage range		85% to 110% of rated supply voltage
Power consumption	E5EC-800/ E5EC-B-800	Models with option selection of 800: 6.6 VA max. at 100 to 240 VAC, and 4.1 VA max. at 24 VAC or 2.3 W max. at 24 VDC All other models: 8.3 VA max. at 100 to 240 VAC, and 5.5 VA max. at 24 VAC or 3.2 W max. at 24 VDC
	E5AC-800	Models with option selection of 800: 7.0 VA max. at 100 to 240 VAC, and 4.2 VA max. at 24 VAC or 2.4 W max. at 24 VDC All other models: 9.0 VA max. at 100 to 240 VAC, and 5.6 VA max. at 24 VAC or 3.4 W max. at 24 VDC
Sensor input		Temperature input Thermocouple: K, J, T, E, L, U, N, R, S, B, C/W, or PL II Platinum resistance thermometer: Pt100 or JPt100 Infrared temperature sensor (ES1B): 10 to 70°C, 60 to 120°C, 115 to 165°C, or 140 to 260°C Analog input Current input: 4 to 20 mA or 0 to 20 mA Voltage input: 1 to 5 V, 0 to 5 V, or 0 to 10 V
Input impedance		Current input: 150 Ω max., Voltage input: 1 MΩ min. (Use a 1:1 connection when connecting the ES2-HB-N/THB-N.)
Control method		ON/OFF control or 2-PID control (with auto-tuning)
Control output	Relay output	SPST-NO, 250 VAC, 5 A (resistive load), electrical life: 100,000 operations, minimum applicable load: 5 V, 10mA (reference value)
	Voltage output (for driving SSR)	Output voltage: 12 VDC ±20% (PNP), max. load current: 40 mA, with short-circuit protection circuit (The maximum load current is 21 mA for models with two control outputs.)
	Linear current output	4 to 20 mA DC/0 to 20 mA DC, load: 500 Ω max., resolution: approx. 10,000
Auxiliary output	Number of outputs	E5EC-800: 0 or 2 (depend on model), E5EC-B-800: 2 E5AC-800: 0, 1, 2 or 3 (depend on model)
	Output specifications	SPST-NO relay outputs, 250 VAC, 3 A (resistive load), Electrical life: 100,000 operations, Minimum applicable load: 10 mA at 5V (reference value)
Event input	Number of inputs	E5EC-800/E5AC-800: 2 or 4 (depend on model), E5EC-B-800: 2
	External contact input specifications	Contact input: ON: 1 kΩ max., OFF: 100 kΩ min.
		Non-contact input: ON: Residual voltage: 1.5 V max., OFF: Leakage current: 0.1 mA max. Current flow: Approx. 7 mA per contact
Potentiometer input *		100 Ω to 10 kΩ
Setting method		Digital setting using front panel keys
Indication method		11-segment digital display and individual indicators Character height: E5EC-800/E5EC-B-800: PV: 18.0 mm, SV: 11.0 mm, MV: 7.8 mm E5AC-800: PV: 25.0 mm, SV: 15.0 mm, MV: 9.5 mm
Multi SP		Up to eight set points (SP0 to SP7) can be saved and selected using event inputs, key operations, or serial communications.
Bank switching		None
Other functions		Manual output, heating/cooling control, loop burnout alarm, SP ramp, other alarm functions, heater burnout (HB) alarm (including SSR failure (HS) alarm), 40% AT, 100% AT, MV limiter, input digital filter, self tuning, PV input shift, run/stop, protection functions, temperature status display, moving average of input value, FB moving average*
Ambient operating temperature		-10 to 55°C (with no condensation or icing)
Ambient operating humidity		25% to 85%
Storage temperature		-25 to 65°C (with no condensation or icing)
Altitude		2,000 m max.
Recommended fuse		T2A, 250 VAC, time lag, low-breaking capacity
Installation environment		Overvoltage category II, Pollution Degree 2 (EN/IEC/UL 61010-1)

* There are no optional functions for the E5EC-B-800. Refer to Model Number Legend on page 22.

Input Ranges (Universal inputs)

● Thermocouple/Platinum Resistance Thermometer

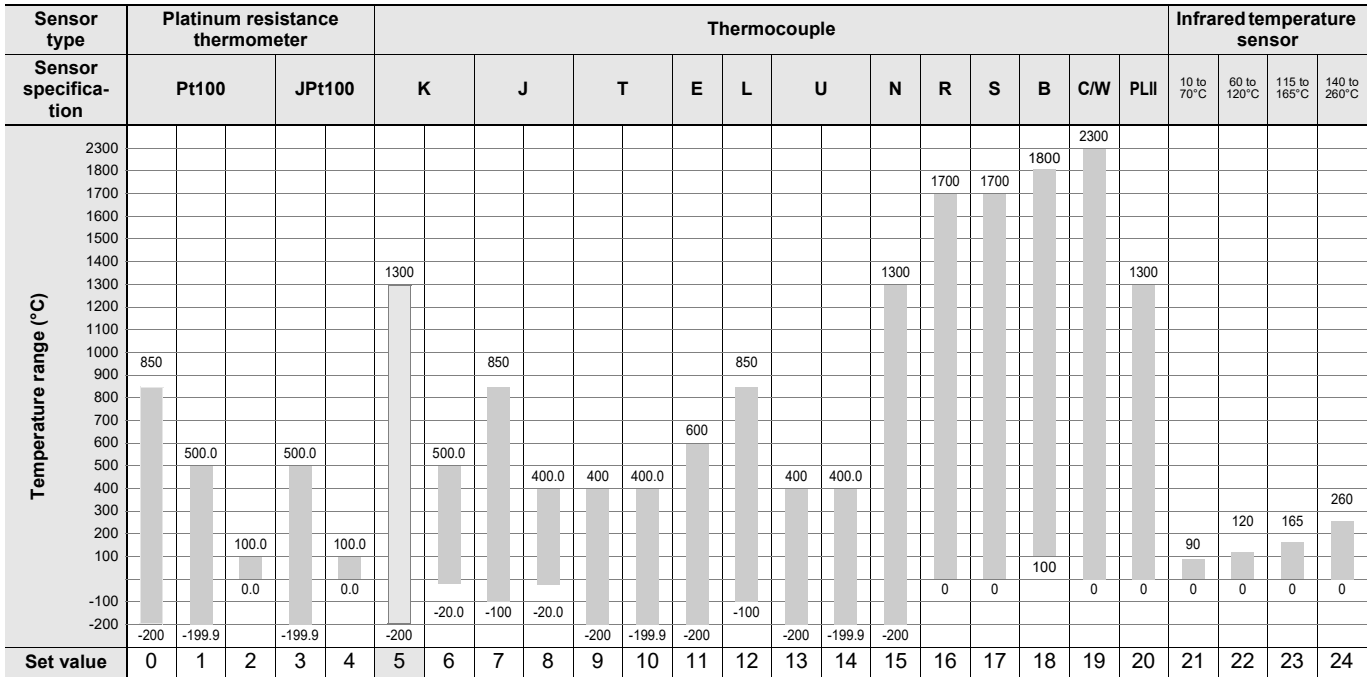

Shaded settings are the default settings.

The applicable standards for the input types are as follows:

K, J, T, E, N, R, S, B: JIS C 1602-2015, IEC 60584-1

JPt100: JIS C 1604-1989, JIS C 1606-1989

L: Fe-CuNi, DIN 43710-1985

Pt100: JIS C 1604-1997, IEC 60751

U: Cu-CuNi, DIN 43710-1985

PL II: According to Platinel II electromotive force charts from BASF (previously Engelhard)

C/W: W5Re/W26Re, JIS C 1602-2015, ASTM E988-1990

● Analog input

Input type	Current		Voltage		
Input specification	4 to 20 mA	0 to 20 mA	1 to 5 V	0 to 5 V	0 to 10 V
Setting range	Usable in the following ranges by scaling: -1999 to 9999, -199.9 to 999.9, -19.99 to 99.99 or -1.999 to 9.999				
Set value	25	26	27	28	29

Alarm type

Each alarm can be independently set to one of the following 19 alarm types. The default is 2: Upper limit. (see note.)

Auxiliary outputs are allocated for alarms. ON delays and OFF delays (0 to 999 s) can also be specified.

Note: In the default settings for models with HB or HS alarms, alarm 1 is set to a heater alarm (HA) and the Alarm Type 1 parameter is not displayed. To use alarm 1, set the output assignment to alarm 1.

Set value	Alarm type	Alarm output operation		Description of function
		When alarm value X is positive	When alarm value X is negative	
0	Alarm function OFF	Output OFF		No alarm
1	Upper- and lower-limit *1		*2	Set the upward deviation in the set point for the alarm upper limit (H) and the lower deviation in the set point for the alarm lower limit (L). The alarm is ON when the PV is outside this deviation range.
2 (default)	Upper-limit			Set the upward deviation in the set point by setting the alarm value (X). The alarm is ON when the PV is higher than the SP by the deviation or more.
3	Lower-limit			Set the downward deviation in the set point by setting the alarm value (X). The alarm is ON when the PV is lower than the SP by the deviation or more.
4	Upper- and lower-limit range *1		*3	Set the upward deviation in the set point for the alarm upper limit (H) and the lower deviation in the set point for the alarm lower limit (L). The alarm is ON when the PV is inside this deviation range.
5	Upper- and lower-limit with standby sequence *1	*5	*4	A standby sequence is added to the upper- and lower-limit alarm (1). *6
6	Upper-limit with standby sequence			A standby sequence is added to the upper-limit alarm (2). *6
7	Lower-limit with standby sequence			A standby sequence is added to the lower-limit alarm (3). *6
8	Absolute-value upper-limit			The alarm will turn ON if the process value is larger than the alarm value (X) regardless of the set point.
9	Absolute-value lower-limit			The alarm will turn ON if the process value is smaller than the alarm value (X) regardless of the set point.
10	Absolute-value upper-limit with standby sequence			A standby sequence is added to the absolute-value upper-limit alarm (8). *6
11	Absolute-value lower-limit with standby sequence			A standby sequence is added to the absolute-value lower-limit alarm (9). *6
12	LBA (alarm 1 type only)	-		*7
13	PV change rate alarm	-		*8
14	SP absolute value upper limit alarm			This alarm type turns ON the alarm when the set point (SP) is higher than the alarm value (X).
15	SP absolute value lower limit alarm			This alarm type turns ON the alarm when the set point (SP) is lower than the alarm value (X).
16	MV absolute value upper limit alarm *9	Standard Control 	Standard Control 	This alarm type turns ON the alarm when the manipulated variable (MV) is higher than the alarm value (X).
		Heating/Cooling Control (Heating MV) 	Heating/Cooling Control (Heating MV) Always ON	
17	MV absolute value lower limit alarm *9	Standard Control 	Standard Control 	This alarm type turns ON the alarm when the manipulated variable (MV) is lower than the alarm value (X).
		Heating/Cooling Control (Cooling MV) 	Heating/Cooling Control (Cooling MV) Always ON	

*1 With set values 1, 4 and 5, the upper and lower limit values can be set independently for each alarm type, and are expressed as "L" and "H."

*2 Set value: 1, Upper- and lower-limit alarm

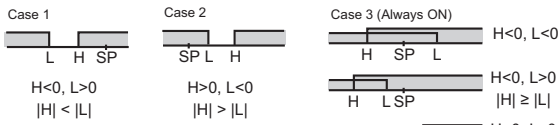

*3 Set value: 4, Upper- and lower-limit range

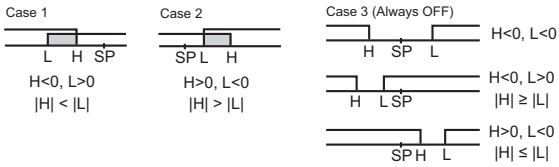

*4 Set value: 5, Upper- and lower-limit with standby sequence
For Upper- and Lower-Limit Alarm Described Above *2

• Case 1 and 2

Always OFF when the upper-limit and lower-limit hysteresis overlaps.

• Case 3: Always OFF

*5 Set value: 5, Upper- and lower-limit with standby sequence

Always OFF when the upper-limit and lower-limit hysteresis overlaps.

*6 Refer to the E5□C Digital Temperature Controllers User's Manual (Cat. No. H174) for information on the operation of the standby sequence.

*7 Refer to the E5□C Digital Temperature Controllers User's Manual (Cat. No. H174) for information on the PV change rate alarm. This setting cannot be used with a position-proportional model.

*8 Refer to the E5□C Digital Temperature Controllers User's Manual (Cat. No. H174) for information on the PV change rate alarm.

*9 When heating/cooling control is performed, the MV absolute upper limit alarm functions only for the heating operation and the MV absolute lower limit alarm functions only for the cooling operation.

Characteristics

Indication accuracy (at the ambient temperature of 23°C)		Thermocouple: ($\pm 0.3\%$ of indication value or $\pm 1^\circ\text{C}$, whichever is greater) ± 1 digit max. *1 Platinum resistance thermometer: ($\pm 0.2\%$ of indication value or $\pm 0.8^\circ\text{C}$, whichever is greater) ± 1 digit max. Analog input: $\pm 0.2\%$ FS ± 1 digit max. CT input: $\pm 5\%$ FS ± 1 digit max. Potentiometer input: $\pm 5\%$ FS ± 1 digit max.
Influence of temperature *2		Thermocouple input (R, S, B, C/W, PL II): ($\pm 1\%$ of indication value or $\pm 10^\circ\text{C}$, whichever is greater) ± 1 digit max. Other thermocouple input: ($\pm 1\%$ of indication value or $\pm 4^\circ\text{C}$, whichever is greater) ± 1 digit max. *3 Platinum resistance thermometer: ($\pm 1\%$ of indication value or $\pm 2^\circ\text{C}$, whichever is greater) ± 1 digit max. Analog input: $\pm 1\%$ FS ± 1 digit max. CT input: $\pm 5\%$ FS ± 1 digit max.
Influence of voltage *2		
Influence of EMS. (at EN 61326-1)		
Input sampling period		50ms
Hysteresis		Temperature input: 0.1 to 999.9°C or °F (in units of 0.1°C or °F) Analog input: 0.01% to 99.99% FS (in units of 0.01% FS)
Proportional band (P)		Temperature input: 0.1 to 999.9°C or °F (in units of 0.1°C or °F) Analog input: 0.1 to 999.9% FS (in units of 0.1% FS)
Integral time (I)		Standard, heating/cooling, or Position-proportional (Close) 0 to 9999 s (in units of 1 s), 0.0 to 999.9 s (in units of 0.1 s) Position-proportional (Floating) 1 to 9999 s (in units of 1 s), 0.1 to 999.9 s (in units of 0.1 s)
Derivative time (D)		0 to 9999 s (in units of 1 s), 0.0 to 999.9 s (in units of 0.1 s) *4
Proportional band (P) for cooling		Temperature input: 0.1 to 999.9°C or °F (in units of 0.1°C or °F) Analog input: 0.1 to 999.9% FS (in units of 0.1% FS)
Integral time (I) for cooling		0 to 9999 s (in units of 1 s), 0.0 to 999.9 s (in units of 0.1 s) *4
Derivative time (D) for cooling		0 to 9999 s (in units of 1 s), 0.0 to 999.9 s (in units of 0.1 s) *4
Control period		0.1, 0.2, 0.5, 1 to 99 s (in units of 1 s)
Manual reset value		0.0 to 100.0% (in units of 0.1%)
Alarm setting range		-1999 to 9999 (decimal point position depends on input type)
Affect of signal source resistance		Thermocouple: $0.1^\circ\text{C}/\Omega$ max. (100 Ω max.) Platinum resistance thermometer: $0.1^\circ\text{C}/\Omega$ max. (10 Ω max.)
Insulation resistance		20 M Ω min. (at 500 VDC)
Dielectric strength		3,000 VAC, 50/60 Hz for 1 min between terminals of different charge
Vibration	Malfunction	10 to 55 Hz, 20 m/s ² for 10 min each in X, Y, and Z directions
	Resistance	10 to 55 Hz, 20 m/s ² for 2 hrs each in X, Y, and Z directions
Shock	Malfunction	100 m/s ² , 3 times each in X, Y, and Z directions
	Resistance	300 m/s ² , 3 times each in X, Y, and Z directions
Weight	E5EC-800/ E5EC-B-800	Controller: Approx. 210 g, Adapter: Approx. 4 g \times 2
	E5AC-800	Controller: Approx. 250 g, Adapter: Approx. 4 g \times 2
Degree of protection		Front panel: IP66, Rear case: IP20, Terminals: IP00
Memory protection		Non-volatile memory (number of writes: 1,000,000 times)
Standards	Approved standards	cULus: UL 61010-1/CSA C22.2 No.61010-1, Korean wireless regulations (Radio law: KC Mark) (Some models only.) *5, Lloyd's standards *6
	Conformed standards	EN 61010-1 (IEC 61010-1), RCM
EMC		EMI Radiated Interference Electromagnetic Field Strength: EN 55011 Group 1, class A Noise Terminal Voltage: EN 55011 Group 1, class A EMS: ESD Immunity: EN 61326-1 *7 EN 61000-4-2 Electromagnetic Field Immunity: EN 61000-4-3 Burst Noise Immunity: EN 61000-4-4 Conducted Disturbance Immunity: EN 61000-4-6 Surge Immunity: EN 61000-4-5 Voltage Dip/Interrupting Immunity: EN 61000-4-11

*1. The indication accuracy of K thermocouples in the -200 to 1300°C range, T and N thermocouples at a temperature of -100°C max., and U and L thermocouples at any temperatures is $\pm 2^\circ\text{C} \pm 1$ digit max. The indication accuracy of the B thermocouple at a temperature of 400°C max. is not specified. The indication accuracy of B thermocouples at a temperature of 400 to 800°C is $\pm 3^\circ\text{C}$ max. The indication accuracy of the R and S thermocouples at a temperature of 200°C max. is $\pm 3^\circ\text{C} \pm 1$ digit max. The indication accuracy of C/W thermocouples is (± 0.3 of PV or $\pm 3^\circ\text{C}$, whichever is greater) ± 1 digit max. The indication accuracy of PL II thermocouples is ($\pm 0.3\%$ of PV or $\pm 2^\circ\text{C}$, whichever is greater) ± 1 digit max.

*2. Ambient temperature: -10°C to 23°C to 55°C, Voltage range: -15% to 10% of rated voltage

*3. K thermocouple at -100°C max.: $\pm 10^\circ\text{C}$ max.

*4. The unit is determined by the setting of the Integral/Derivative Time Unit parameter.

*5. Refer to your OMRON website for the most recent information on applicable models.

*6. Refer to information on maritime standards in *Shipping Standards* on page 65 for compliance with Lloyd's Standards.

*7. Industrial electromagnetic environment (EN/IEC 61326-1 Table 2)

Communications Specifications

Transmission line connection method	RS-485: Multidrop
Communications	RS-485 (two-wire, half duplex)
Synchronization method	Start-stop synchronization
Protocol	CompoWay/F, or Modbus
Baud rate *1	9600, 19200, 38400, or 57600 bps
Transmission code	ASCII
Data bit length *1	7 or 8 bits
Stop bit length *1	1 or 2 bits
Error detection	Vertical parity (none, even, odd) Block check character (BCC) with CompoWay/F or CRC-16 with Modbus *2
Flow control	None
Interface	RS-485
Retry function	None
Communications buffer	217 bytes
Communications response wait time	0 to 99 ms Default: 20 ms

*1 The baud rate, data bit length, stop bit length, and vertical parity can be individually set using the Communications Setting Level.

*2 Modbus is a registered trademark of Schneider Electric.

Communications Functions

Programless communications *1	You can use the memory in the PLC to read and write E5□C parameters, start and stop operation, etc. The E5□C automatically performs communications with PLCs. No communications programming is required. Number of connected Temperature Controllers: 32 max. (Up to 16 for the FX Series) Applicable PLCs OMRON PLCs CS Series, CJ Series, CP Series, NJ Series, or NX1P MELSEC Q Series, L Series, FX3 Series, or iQ-R Series KEYENCE PLCs KEYENCE KV Series
Component Communications *1	When Digital Temperature Controllers are connected, set points and RUN/STOP commands can be sent from the Digital Temperature Controller that is set as the master to the Digital Temperature Controllers that are set as slaves. Slope and offsets can be set for the set point. Number of connected Digital Temperature Controllers: 32 max. (including master)
Copying *2	When Digital Temperature Controllers are connected, the parameters can be copied from the Digital Temperature Controller that is set as the master to the Digital Temperature Controllers that are set as slaves.

MELSEC is a registered trademark of Mitsubishi Electric Corporation.
KEYENCE is a registered trademark of Keyence Corporation.

*1 A Temperature Controller with version 1.1 or higher is required.
A Temperature Controller with version 2.1 or higher is required for the FX Series or the KV Series.

*2 Both the programless communications and the component communications support the copying.

Current Transformer (Order Separately) Ratings

	E54-CT1 E54-CT3	E54-CT1L E54-CT3L
Dielectric strength	1,000 VAC for 1 min	1,500 VAC for 1 min
Vibration resistance	50 Hz, 98 m/s ²	
Weight	E54-CT1: Approx. 11.5 g, E54-CT3: Approx. 50 g	E54-CT1: Approx. 14 g, E54-CT3: Approx. 57 g
Accessories	E54-CT3 Only Armatures (2) Plugs (2)	None

Heater Burnout Alarms and SSR Failure Alarms

CT input (for heater current detection)	Models with detection for single-phase heaters: One input
Maximum heater current	50 A AC
Input current indication accuracy	±5% FS ±1 digit max.
Heater burnout alarm setting range *1	0.1 to 49.9 A (in units of 0.1 A) Minimum detection ON time: 100 ms *3
SSR failure alarm setting range *2	0.1 to 49.9 A (in units of 0.1 A) Minimum detection OFF time: 100 ms *4

*1. For heater burnout alarms, the heater current will be measured when the control output is ON, and the output will turn ON if the heater current is lower than the set value (i.e., heater burnout detection current value).

*2. For SSR failure alarms, the heater current will be measured when the control output is OFF, and the output will turn ON if the heater current is higher than the set value (i.e., SSR failure detection current value).

*3. The value is 30 ms for a control period of 0.1 s or 0.2 s.

*4. The value is 35 ms for a control period of 0.1 s or 0.2 s.

Electrical Life Expectancy Curve for Control Output Relays (Reference Values)

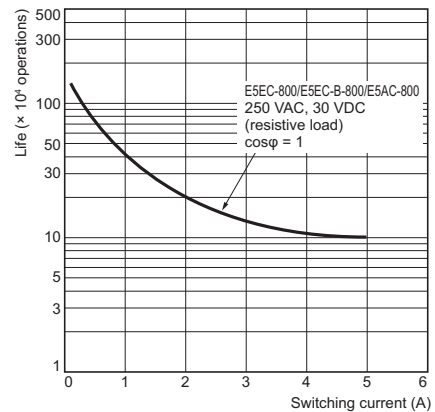

External Connections

E5EC/E5AC-800 (Screw Terminal Blocks)

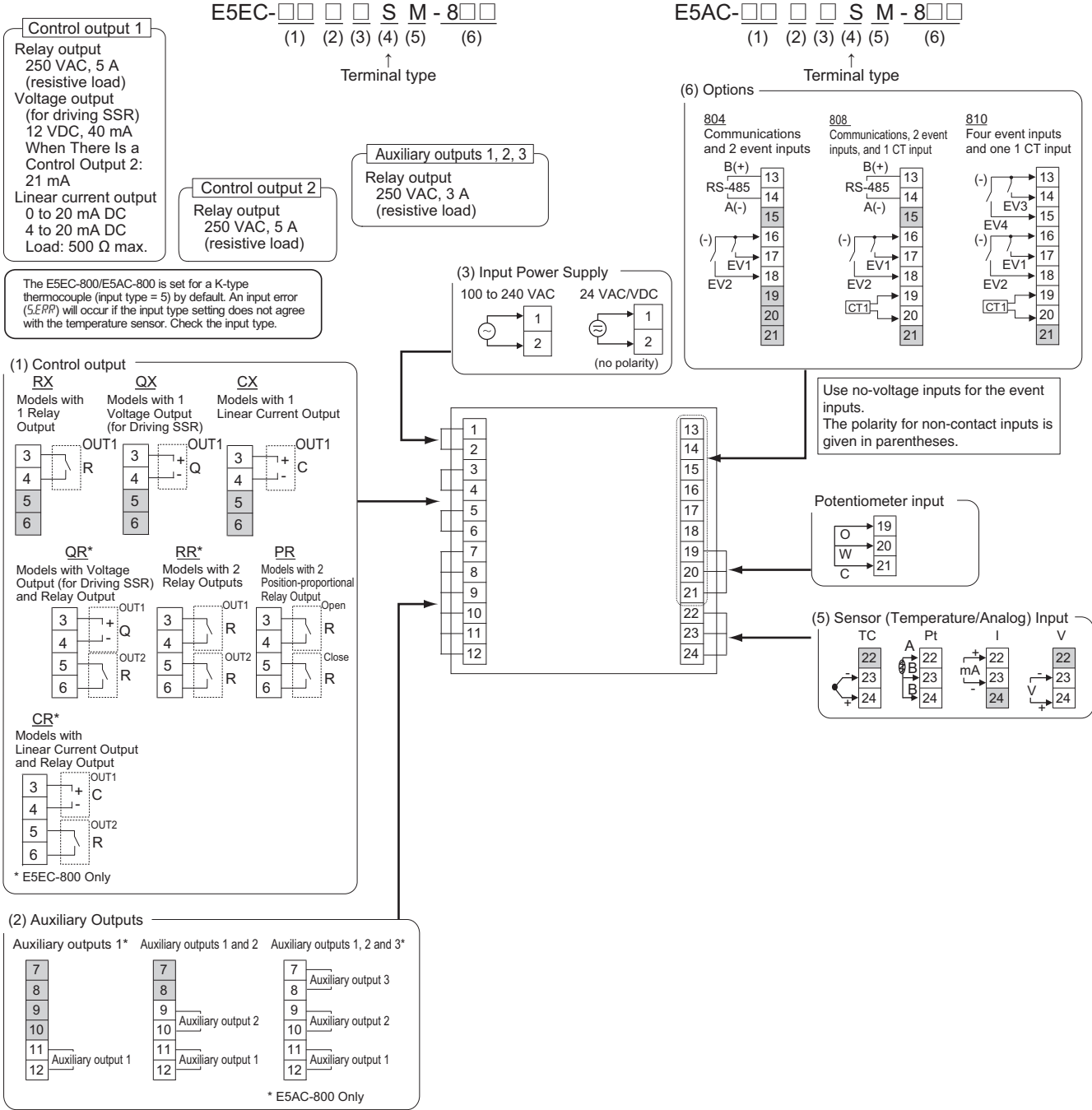

- Note:**
1. The application of the terminals depends on the model.
 2. Do not wire the terminals that are shown with a gray background.
 3. When complying with EMC standards, the cable that connects the sensor must be 30 m or less. If the cable length exceeds 30 m, compliance with EMC standards will not be possible.
 4. Connect M3 crimped terminals.
 5. Due to UL Listing requirements, use the E54-CT1L or E54-CT3L Current Transformer with the factory wiring (internal wiring). Use a UL category XOBA or XOBA7 current transformer that is UL Listed for field wiring (external wiring) and not the factory wiring (internal wiring).

E5EC-800/E5EC-B-800/E5AC-800

E5EC-B-800 (Push-In Plus Terminal Blocks)

E5EC-□□ 2 A B M - 8□□
 (1) (2) (3) (4) (5) (6)

↑
Terminal type

Control output 1
 Relay output
 250 VAC, 5 A (resistive load)
 Voltage output
 (for driving SSR)
 12 VDC, 40 mA
 21 mA if there are two control outputs

Control output 2
 Relay output
 250 VAC, 5 A (resistive load)

Auxiliary outputs 1, 2
 Relay output
 Model with 2 auxiliary outputs: 250 VAC, 3 A (resistive load)

The E5EC-B-800 is set for a K-type thermocouple (input type = 5) by default. An input error (SEERR) will occur if the input type setting does not agree with the temperature sensor. Check the input type.

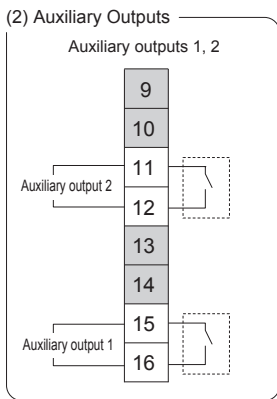
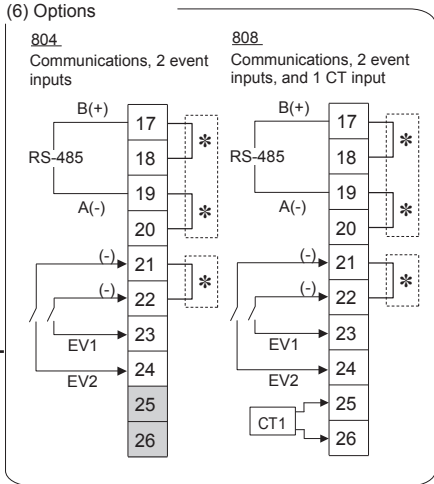
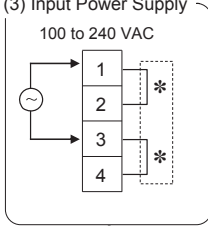
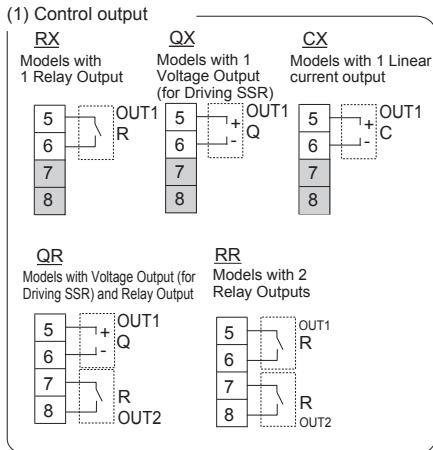

Use no-voltage inputs for the event inputs.
 The polarity for non-contact inputs is given in parentheses.

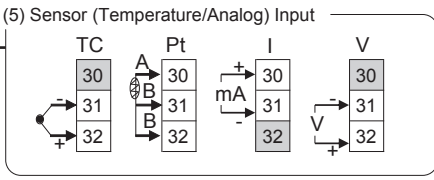

- Note:**
- The application of the terminals depends on the model.
 - Do not wire the terminals that are shown with a gray background.
 - When complying with EMC standards, the cable that connects the sensor must be 30 m or less. If the cable length exceeds 30 m, compliance with EMC standards will not be possible.
 - Refer to *Wiring Precautions for E5□C-B (Controllers with Push-In Plus Terminal Blocks)* on page 71 for wire specifications and wiring methods.
 - Common terminals are indicated with asterisks (*). You can use the input power supply and communications common terminals for crossover wiring. Do not exceed the maximum number of Temperature Controllers given below if you use crossover wiring for the input power supply.
 100 to 240 VAC Controllers: 16 max.

Wiring Example:

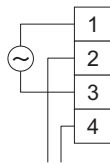

To another E5□C

- Due to UL Listing requirements, use the E54-CT1L or E54-CT3L Current Transformer with the factory wiring (internal wiring). Use a UL category X0BA or X0BA7 current transformer that is UL Listed for field wiring (external wiring) and not the factory wiring (internal wiring).

Isolation/Insulation Block Diagrams

Power Supply	Sensor input, CT input, and potentiometer input
	Communications and event inputs
	Voltage output (for driving SSR) and linear current output
	Relay output
	Auxiliary output 1
	Auxiliary output 2
	Auxiliary output 3

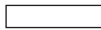
 : Reinforced insulation
 : Functional isolation

Nomenclature

E5EC-800/E5EC-B-800

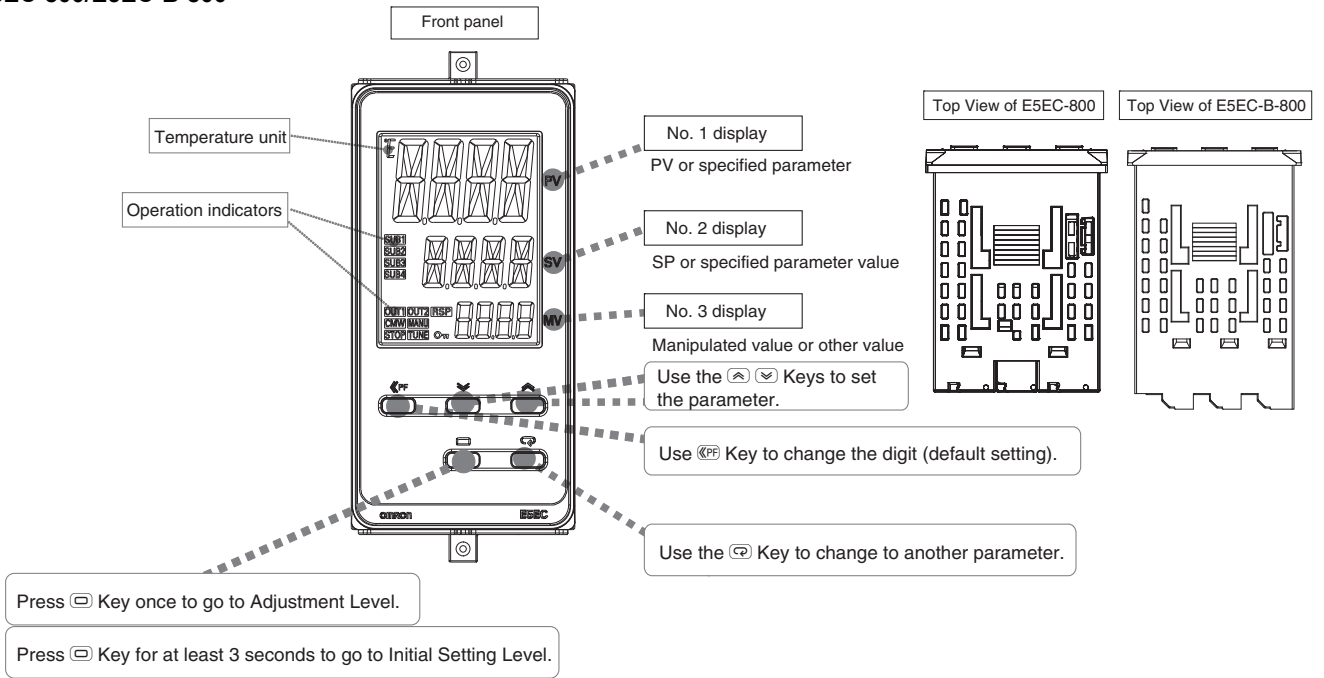

E5AC-800

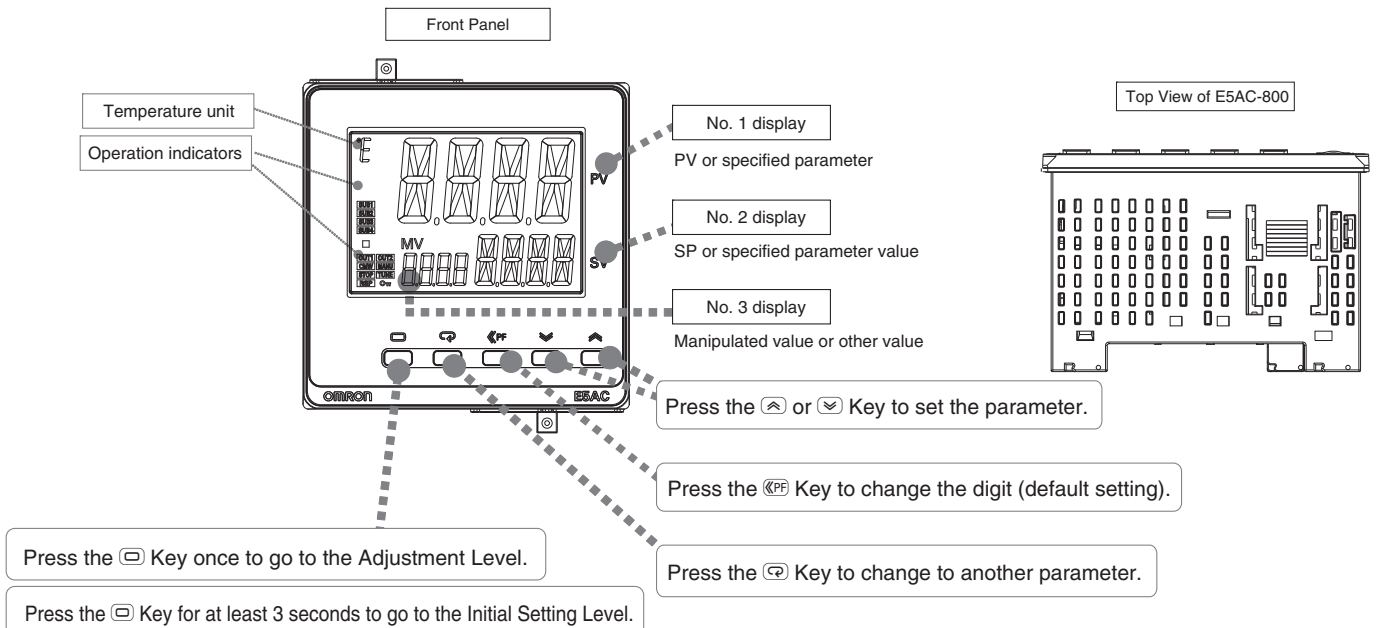

E5EC-800/E5EC-B-800/E5AC-800

Dimensions

(Unit: mm)

Controllers

E5EC-800

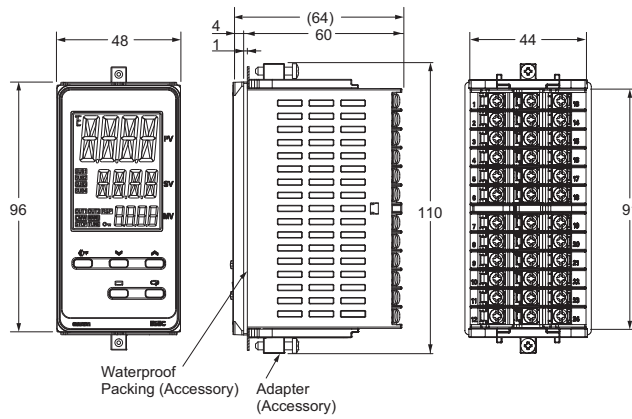

E5EC-B-800

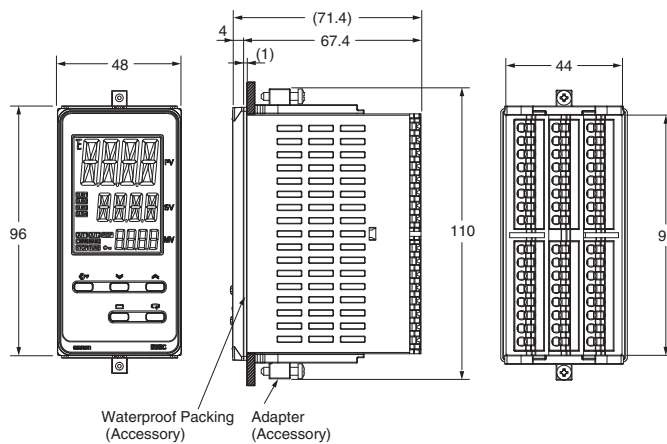

Mounted Separately

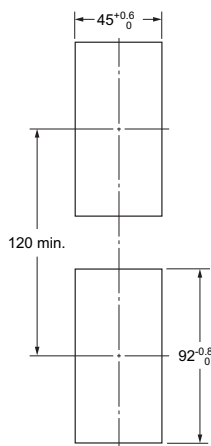

Group Mounted

$$(48 \times \text{number of units} - 2.5)^{+1.0}_0$$

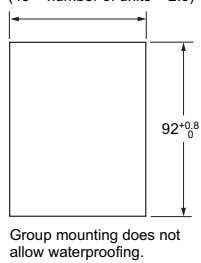

- Recommended panel thickness is 1 to 8 mm.
- Group mounting is not possible in the vertical direction. (Maintain the specified mounting space between Controllers.)
- To mount the Controller so that it is waterproof, insert the waterproof packing onto the Controller.
- When two or more Controllers are mounted, make sure that the surrounding temperature does not exceed the allowable operating temperature specified in the specifications.

E5AC-800

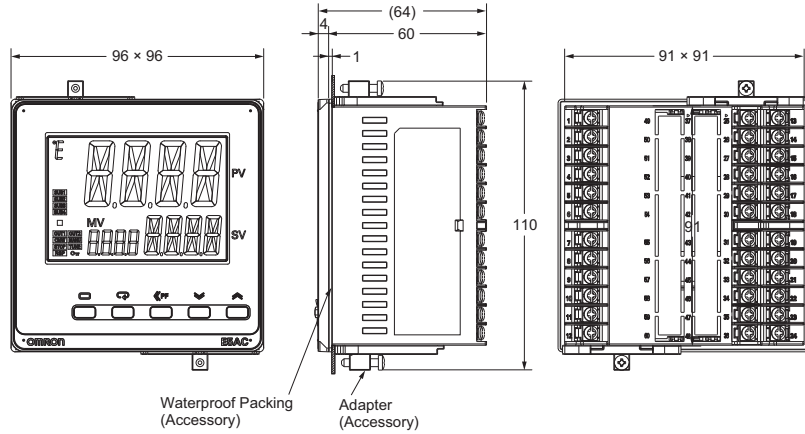

Mounted Separately

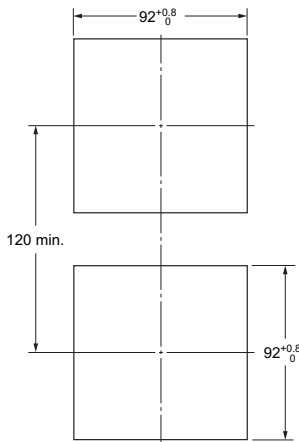

Group Mounted

$$(96 \times \text{number of units} - 3.5) \times 1.0$$

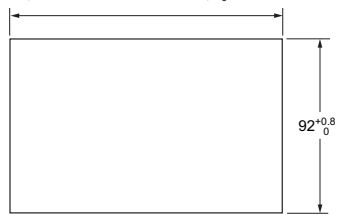

Group mounting does not allow waterproofing.

- Recommended panel thickness is 1 to 8 mm.
- Group mounting is not possible in the vertical direction. (Maintain the specified mounting space between Controllers.)
- To mount the Controller so that it is waterproof, insert the waterproof packing onto the Controller.
- When two or more Controllers are mounted, make sure that the surrounding temperature does not exceed the allowable operating temperature specified in the specifications.

E5EC-800/E5EC-B-800/E5AC-800

Accessories (Order Separately)

● Terminal Covers

E53-COV24 (Three Covers provided.)

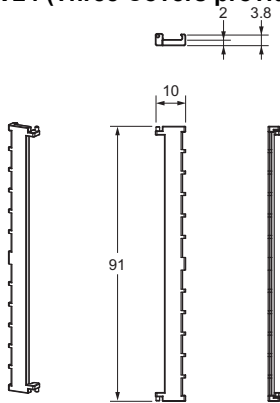

● Waterproof Packing

Y92S-P9 (for DIN 48 × 96)

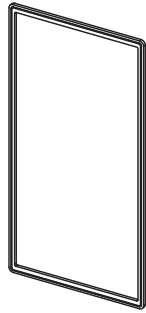

Y92S-P10 (for DIN 96 × 96)

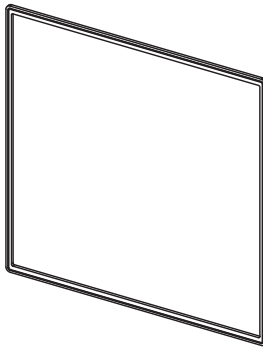

The Waterproof Packing is provided with the Temperature Controller.

Order the Waterproof Packing separately if it becomes lost or damaged.

The degree of protection when the Waterproof Packing is used is IP66.

To maintain an IP66 degree of protection, the Waterproof Packing and the Port Cover for the front-panel Setup Tool port must be periodically replaced because they may deteriorate, shrink, or harden depending on the operating environment.

The replacement period will vary with the operating environment.

Check the required period in the actual application. Use 3 years or sooner as a guideline.

● Mounting Adapter

Y92F-51

(Two Adapters provided.)

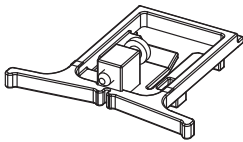

One pair is provided with the Controller.

Order this Adapter separately if it becomes lost or damaged.

● Watertight Cover

Y92A-49N (48 × 96)

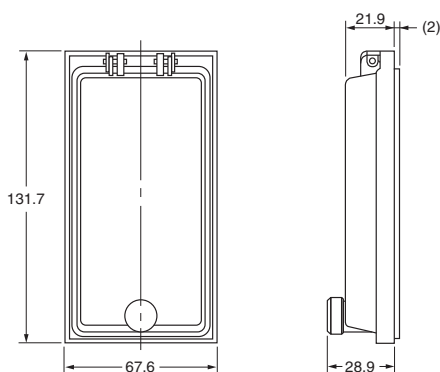

● Watertight Cover

Y92A-96N (96 × 96)

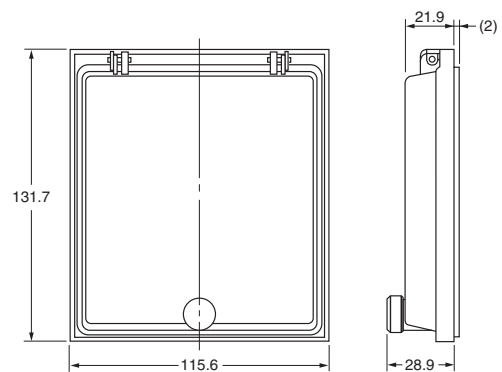

● Current Transformers

E54-CT1

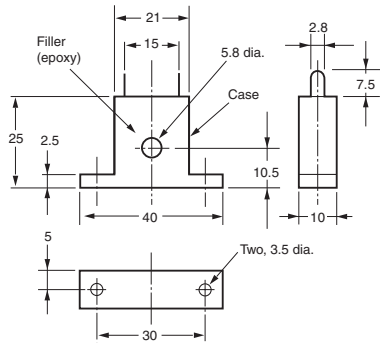
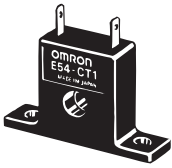

Thru-current (I_o) vs. Output Voltage (E_o)
(Reference Values)
E54-CT1 or E54-CT1L

Maximum continuous heater current: 50 A (50/60 Hz)
Number of windings: 400 ± 2
Winding resistance: $18 \pm 2 \Omega$

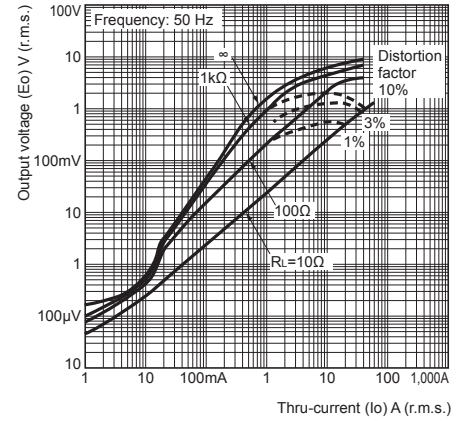

E54-CT1L

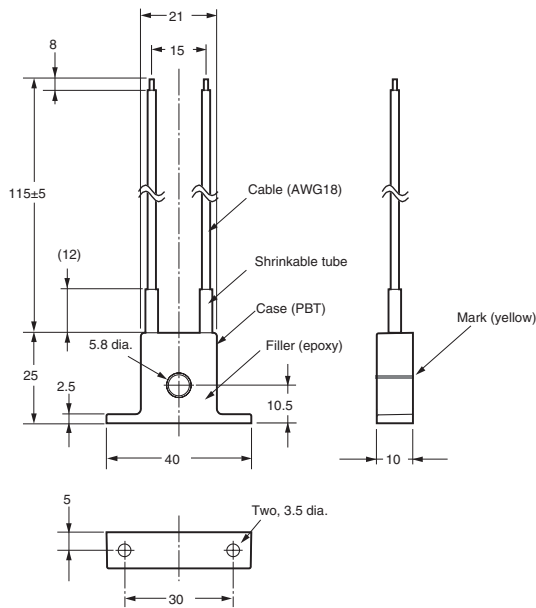
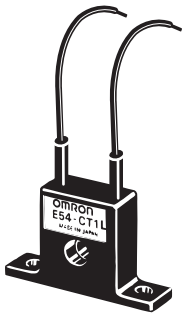

E54-CT3

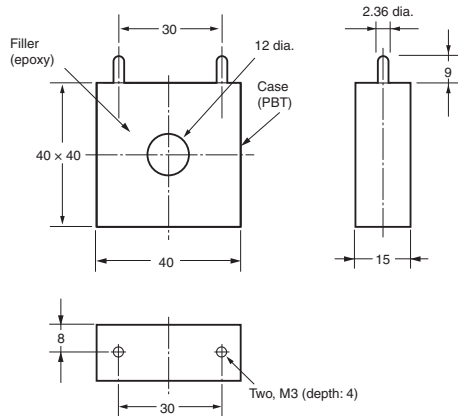

E54-CT3 Accessories

• Armature

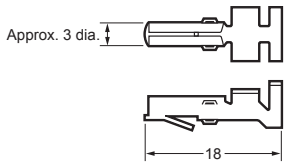

Connection Example

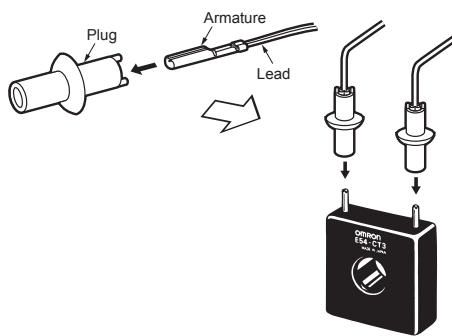

• Plug

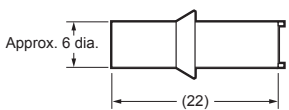

Thru-current (I_o) vs. Output Voltage (E_o) (Reference Values) E54-CT3 or E54-CT3L

Maximum continuous heater current: 120 A (50/60 Hz)
(Maximum continuous heater current for an OMRON Digital Temperature Controller is 50 A.)

Number of windings: 400±2

Winding resistance: 8±0.8 Ω

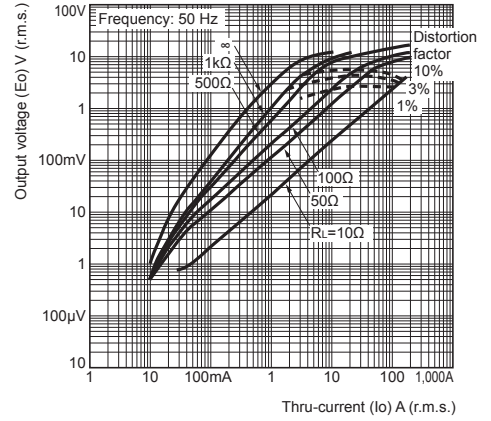

E54-CT3L

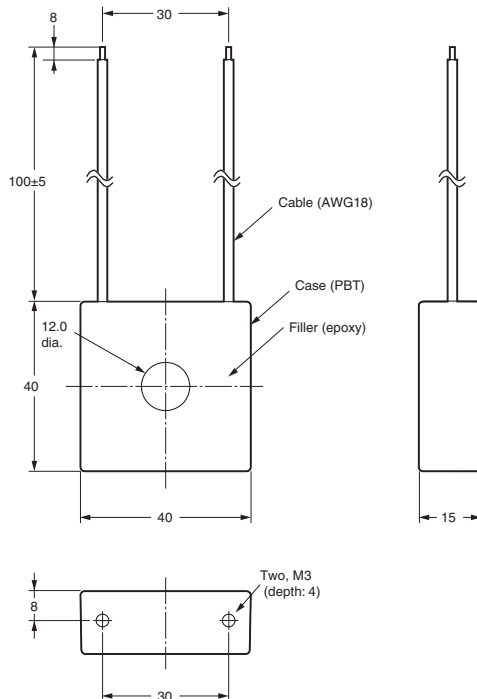

Digital Temperature Controller

E5DC-800/E5DC-B-800

(22.5 mm Wide, and DIN Track-mounting Type)

The E5DC-800 Mounts to DIN Track and Is Ideal for Connections to HMIs and PLCs. It provides the Same Easy Operation and Advanced Performance as the Rest of the E5□C-800 Series.

Models with Push-In Plus Terminal Blocks Added to Lineup.

- A slim body at 85 × 22.5 mm (D × W) that fits into narrow control panels and mounts to DIN Track.
- Removable terminal block for easy replacement to simplify maintenance.
- Select from models with screw terminal blocks and models with Push-In Plus terminal blocks for reduced wiring work.
- No need for power supply and communication line wiring when using connectors with Push-In Plus terminal blocks. (Maximum connectable units: 16)
- High-speed sampling at 50 ms for applications with high-speed temperature increases.
- Easy connections to a PLC with programless communications.
- Models are available with up to 2 auxiliary outputs and 1 event input to complete basic functions.
- A white PV display (height: 8.5 mm) is easy to read when setting up, checking alarms, and making settings in a control panel.



* CSA conformance evaluation by UL.



22.5 mm Wide, and DIN Track-mounting Type Models with Push-In Plus Terminal Blocks
E5DC-B-800

22.5 mm Wide, and DIN Track-mounting Type Models with Screw Terminal Blocks
E5DC-800

Refer to your OMRON website for the most recent information on applicable safety standards.

Refer to *Safety Precautions* on page 62.

Main I/O Functions

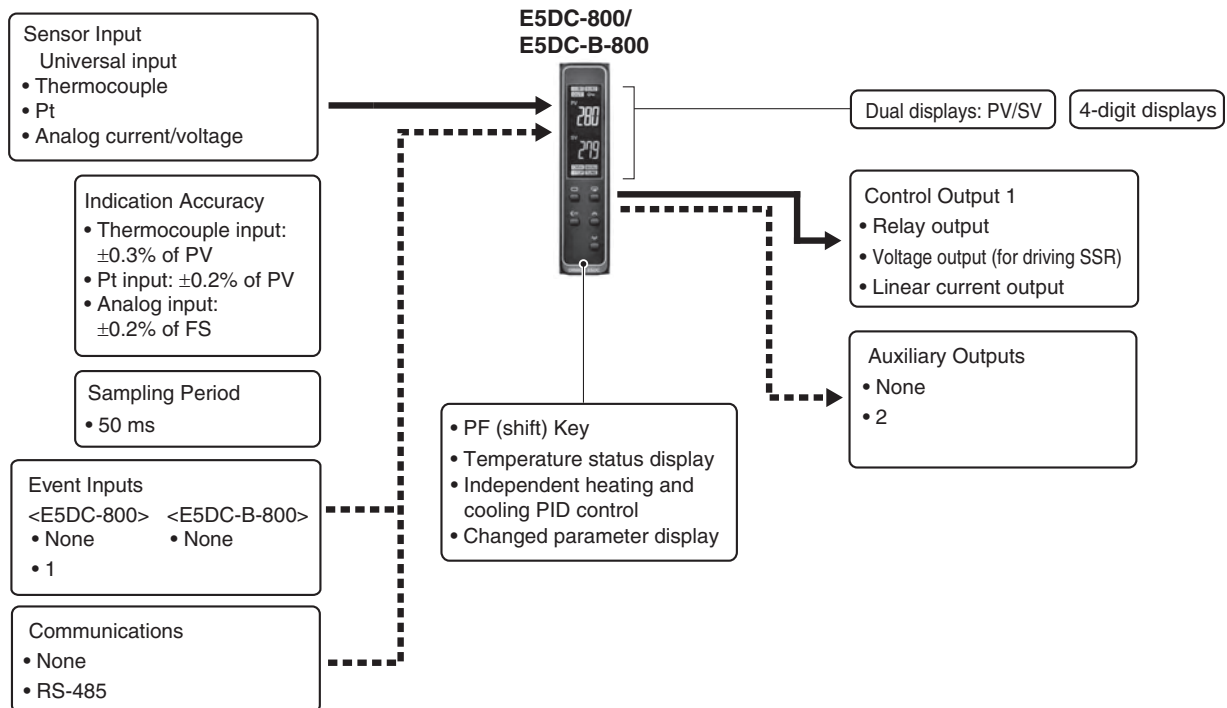

E5DC-800/E5DC-B-800

Model Number Legend and Standard Models

Model Number Legend

● Models with Screw Terminals

E5DC-800 22.5 × 96 mm

Control output	Auxiliary output	Communications	Heater burnot	Event inputs	Power supply voltage	Model *2	
Relay output	---	RS-485			100 to 240 VAC	E5DC-RX0ASM-815	
						E5DC-RX0AUM-815	
Voltage output						E5DC-QX0ASM-815	
						E5DC-QX0AUM-815	
Linear current output *1						E5DC-CX0ASM-815	
						E5DC-CX0AUM-815	
Relay output	---				24 VAC/VDC	E5DC-RX0DSM-815	
						E5DC-RX0DUM-815	
Voltage output						E5DC-QX0DSM-815	
						E5DC-QX0DUM-815	
Linear current output *1						E5DC-CX0DSM-815	
						E5DC-CX0DUM-815	
Relay output	Two	---			100 to 240 VAC	E5DC-RX2ASM-800	
						E5DC-RX2AUM-800	
Voltage output						E5DC-QX2ASM-800	
						E5DC-QX2AUM-800	
Linear current output *1						E5DC-CX2ASM-800	
						E5DC-CX2AUM-800	
Relay output		RS-485	Detection for Single-phase heater			100 to 240 VAC	E5DC-RX2DSM-800
							E5DC-RX2DUM-800
Voltage output							E5DC-QX2DSM-800
							E5DC-QX2DUM-800
Linear current output *1							E5DC-CX2DSM-800
							E5DC-CX2DUM-800
Relay output	---	Detection for Single-phase heater			24 VAC/VDC	E5DC-RX2DSM-802	
						E5DC-RX2DUM-802	
Voltage output						E5DC-QX2DSM-802	
						E5DC-QX2DUM-802	
Linear current output *1						E5DC-CX2DSM-815	
						E5DC-CX2DUM-815	
Relay output	---	Detection for Single-phase heater		One	100 to 240 VAC	E5DC-RX2ASM-817	
						E5DC-RX2AUM-817	
Voltage output						E5DC-QX2ASM-817	
						E5DC-QX2AUM-817	
Linear current output *1						E5DC-CX2ASM-816	
						E5DC-CX2AUM-816	
Relay output	---	Detection for Single-phase heater			24 VAC/VDC	E5DC-RX2DSM-817	
						E5DC-RX2DUM-817	
Voltage output						E5DC-QX2DSM-817	
						E5DC-QX2DUM-817	
Linear current output *1						E5DC-CX2DSM-816	
						E5DC-CX2DUM-816	

*1 The control output can be used as a simple transfer output for the Digital Temperature Controllers manufactured in July 2014 or later.

*2 Option 800 can be selected only if two auxiliary outputs are selected.

Options 802 and 817 can be selected only if the control output is a relay output or voltage output and two auxiliary outputs are selected.

Option 815 cannot be selected if the control output is a relay output or voltage output and two auxiliary outputs are selected.

Options 816 can be selected only if the control output is a linear current output and two auxiliary outputs are selected.

Model Number Legend

● Models with Push-In Plus Terminal Blocks

E5DC-B-800 22.5 × 96 mm

Control output	Auxiliary output	Communications	Heater burnot	Power supply voltage	Model *2			
Relay output	-	RS-485	---	100 to 240 VAC	E5DC-RX0ABM-815			
Voltage output					E5DC-QX0ABM-815			
Linear current output *1					E5DC-CX0ABM-815			
Relay output				-	RS-485	---	24 VAC/VDC	E5DC-RX0DBM-815
Voltage output								E5DC-QX0DBM-815
Linear current output *1								E5DC-CX0DBM-815
Relay output	Two	-	---				100 to 240 VAC	E5DC-RX2ABM-800
Voltage output								E5DC-QX2ABM-800
Linear current output *1								E5DC-CX2ABM-800
Relay output				Two	-	---	24 VAC/VDC	E5DC-RX2DBM-800
Voltage output								E5DC-QX2DBM-800
Linear current output *1								E5DC-CX2DBM-800
Relay output	Two	RS-485	---				100 to 240 VAC	E5DC-RX2ABM-802
Voltage output								E5DC-QX2ABM-802
Linear current output *1								E5DC-CX2ABM-815
Relay output				Two	RS-485	---	24 VAC/VDC	E5DC-RX2DBM-802
Voltage output								E5DC-QX2DBM-802
Linear current output *1								E5DC-CX2DBM-815

*1 The control output can be used as a simple transfer output for the Digital Temperature Controllers manufactured in July 2014 or later.

*2 Option 800 can be selected only if two auxiliary outputs are selected.

Option 802 can be selected only if the control output is a relay output or voltage output and two auxiliary outputs are selected.

Option 815 cannot be selected if the control output is a relay output or voltage output and two auxiliary outputs are selected.

Heating and Cooling Control

●Using Heating and Cooling Control

(1) Control Output Assignment

An auxiliary output is used as the cooling control output.

(2) Control

If PID control is used, you can set PID control separately for heating and cooling.

This allows you to handle control systems with different heating and cooling response characteristics.

Optional Products (Order Separately)

Terminal Unit

Model
E5DC-SCT1S

Push-In Plus Terminal Unit

Model
E5DC-SCT1B

Current Transformers (CTs)

Hole diameter	Model
5.8 mm	E54-CT1
5.8 mm	E54-CT1L *
12.0 mm	E54-CT3
12.0 mm	E54-CT3L *

* Lead wires are included with these CTs. If UL certification is required, use these CTs.

Mounting Adapters

Model
Y92F-53 (2pcs)

Short Bars (for E5DC-800)

Model
Y92S-P11 (4pcs)

End Plate

Model
PFP-M

Spacer

Model
PFP-S

DIN Tracks

Model
PFP-100N
PFP-50N

Unit Labels

Model
Y92S-L2

End Cover

Model
Y92F-54

Connector Cover (for E5DC-B-800)

Model
E53-COV26

Specifications

Ratings

Power supply voltage	A in model number: 100 to 240 VAC, 50/60 Hz D in model number: 24 VAC, 50/60 Hz; 24 VDC	
Operating voltage range	85% to 110% of rated supply voltage	
Power consumption	4.9 VA max. at 100 to 240 VAC, and 2.8 VA max. at 24 VDC or 1.5 W max. at 24 VDC	
Sensor input	Temperature input Thermocouple: K, J, T, E, L, U, N, R, S, B, C/W, or PL II Platinum resistance thermometer: Pt100 or JPt100 Infrared temperature sensor (ES1B): 10 to 70°C, 60 to 120°C, 115 to 165°C, or 140 to 260°C Analog input Current input: 4 to 20 mA or 0 to 20 mA Voltage input: 1 to 5 V, 0 to 5 V, or 0 to 10 V	
Input impedance	Current input: 150 Ω max., Voltage input: 1 MΩ min. (Use a 1:1 connection when connecting the ES2-HB-N/THB-N.)	
Control method	ON/OFF control or 2-PID control (with auto-tuning)	
Control output	Relay output	SPST-NO, 250 VAC, 3 A (resistive load), electrical life: 100,000 operations, minimum applicable load: 5 V, 10 mA (reference value)
	Voltage output (for driving SSR)	Output voltage 12 VDC ±20% (PNP), max. Load current: 21 mA, with short-circuit protection circuit
	Linear current output	4 to 20 mA DC/0 to 20 mA DC, load: 500 Ω max., resolution: Approx. 10,000
Auxiliary outputs	Number of outputs	2 (depends on model)
	Output specifications	SPST-NO relay outputs: 250 VAC, 2 A (resistive load), Electrical life: 100,000 operations, Minimum applicable load: 10 mA at 5 V (reference value)
Event inputs *1	Number of inputs	1 (depends on model)
	External contact input specifications	Contact input ON: 1 kΩ max., OFF: 100 kΩ min.
		Non-contact input ON: Residual voltage 1.5 V max.; OFF: Leakage current 0.1 mA max. Current flow: approx. 7 mA per contact
Setting method	Digital setting using front panel keys	
Indication method	11-segment digital displays and individual indicators Character height: PV: 8.5 mm, SV: 8.0 mm	
Multi SP	Up to eight set points (SP0 to SP7) can be saved and selected using the event inputs, key operations, or serial communications.*2	
Bank switching	None	
Other functions	Manual output, heating/cooling control, loop burnout alarm, SP ramp, other alarm functions, heater burn-out (HB) alarm (including SSR failure (HS) alarm), 40% AT, 100% AT, MV limiter, input digital filter, self tuning, PV input shift, run/stop, protection functions, temperature status display, moving average of input value, simple transfer output,*3 and work bit message*3	
Ambient operating temperature	-10 to 55°C (with no condensation or icing)	
Ambient operating humidity	25% to 85%	
Storage temperature	-25 to 65°C (with no condensation or icing)	
Altitude	2,000 m max.	
Recommended fuse	T2A, 250 VAC, time lag, low-breaking capacity	
Installation environment	Overvoltage category II, Pollution Degree 2 (EN/IEC/UL 61010-1)	

*1 This function is not supported by the E5DC-B-800. Refer to *Model Number Legend* on page 40.

*2 Only two set points are selectable for event inputs.

*3 Usage is possible for the Digital Temperature Controllers manufactured in July 2014 or later.

Input Ranges

● Thermocouple/Platinum Resistance Thermometer (Universal inputs)

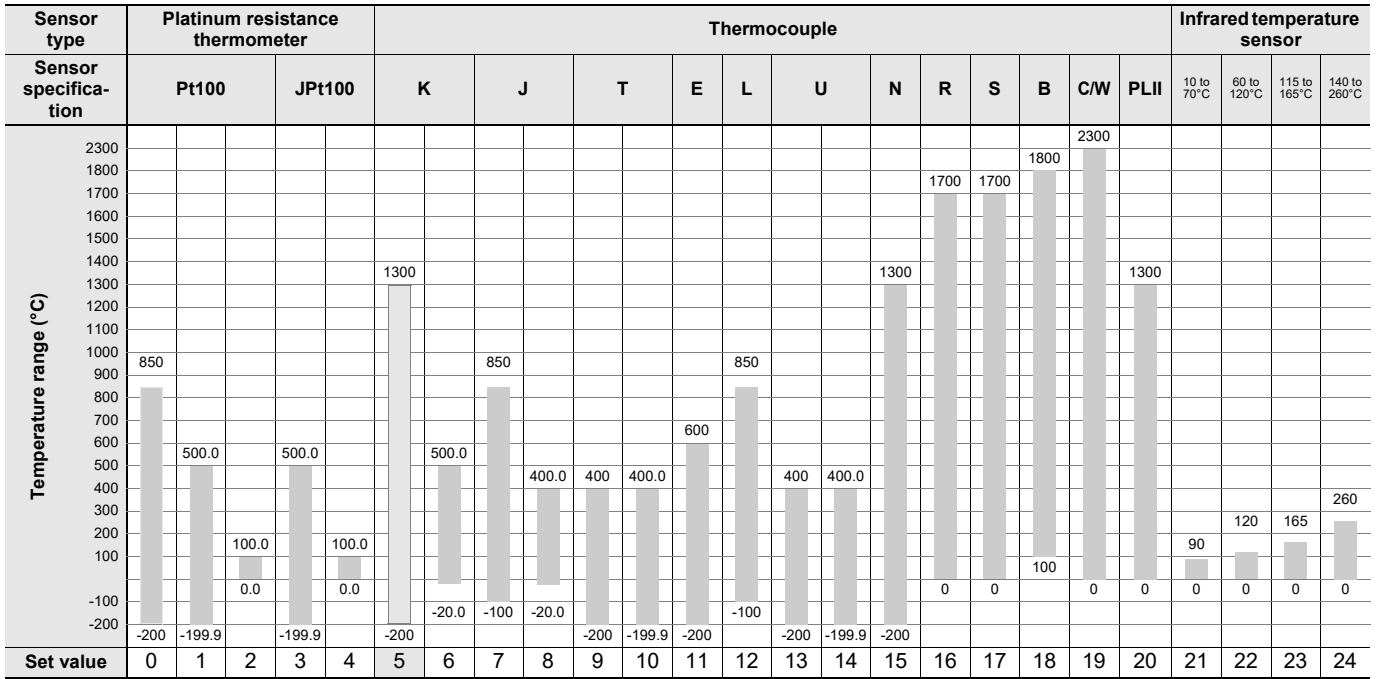

Shaded settings are the default settings.

The applicable standards for the input types are as follows:

K, J, T, E, N, R, S, B: JIS C 1602-2015, IEC 60584-1

L: Fe-CuNi, DIN 43710-1985

U: Cu-CuNi, DIN 43710-1985

C/W: W5Re/W26Re, JIS C 1602-2015, ASTM E988-1990

JPt100: JIS C 1604-1989, JIS C 1606-1989

Pt100: JIS C 1604-1997, IEC 60751

PL II: According to Platinel II electromotive force charts from BASF (previously Engelhard)

● Analog input

Input type	Current		Voltage		
Input specification	4 to 20 mA	0 to 20 mA	1 to 5 V	0 to 5 V	0 to 10 V
Setting range	Usable in the following ranges by scaling: -1999 to 9999, -199.9 to 999.9, -19.99 to 99.99 or -1.999 to 9.999				
Set value	25	26	27	28	29

Alarm Types

Each alarm can be independently set to one of the following 17 alarm types. The default is 2: Upper limit. (See note.)

Auxiliary outputs are allocated to alarms. ON delays and OFF delays (0 to 999 s) can also be specified.

Note: In the default settings for models with HB or HS alarms, alarm 1 is set to a heater alarm (HA) and the Alarm Type 1 parameter is not displayed.

To use alarm 1, set the output assignment to alarm 1.

Set value	Alarm type	Alarm output operation		Description of function
		When alarm value X is positive	When alarm value X is negative	
0	Alarm function OFF	Output OFF		No alarm
1	Upper- and lower-limit *1		*2	Set the upward deviation in the set point for the alarm upper limit (H) and the lower deviation in the set point for the alarm lower limit (L). The alarm is ON when the PV is outside this deviation range.
2 (default)	Upper-limit			Set the upward deviation in the set point by setting the alarm value (X). The alarm is ON when the PV is higher than the SP by the deviation or more.
3	Lower-limit			Set the downward deviation in the set point by setting the alarm value (X). The alarm is ON when the PV is lower than the SP by the deviation or more.
4	Upper- and lower-limit range *1		*3	Set the upward deviation in the set point for the alarm upper limit (H) and the lower deviation in the set point for the alarm lower limit (L). The alarm is ON when the PV is inside this deviation range.
5	Upper- and lower-limit with standby sequence *1		*4	A standby sequence is added to the upper- and lower-limit alarm (1). *6
6	Upper-limit with standby sequence			A standby sequence is added to the upper-limit alarm (2). *6
7	Lower-limit with standby sequence			A standby sequence is added to the lower-limit alarm (3). *6
8	Absolute-value upper-limit			The alarm will turn ON if the process value is larger than the alarm value (X) regardless of the set point.
9	Absolute-value lower-limit			The alarm will turn ON if the process value is smaller than the alarm value (X) regardless of the set point.
10	Absolute-value upper-limit with standby sequence			A standby sequence is added to the absolute-value upper-limit alarm (8). *6
11	Absolute-value lower-limit with standby sequence			A standby sequence is added to the absolute-value lower-limit alarm (9). *6
12	LBA (alarm 1 type only)	-		*7
13	PV change rate alarm	-		*8
14	SP absolute-value upper-limit alarm			This alarm type turns ON the alarm when the set point (SP) is higher than the alarm value (X).
15	SP absolute-value lower-limit alarm			This alarm type turns ON the alarm when the set point (SP) is lower than the alarm value (X).
16	MV absolute-value upper-limit alarm *9	Standard Control	Standard Control	This alarm type turns ON the alarm when the manipulated variable (MV) is higher than the alarm value (X).
17	MV absolute-value lower-limit alarm *9	Heating/Cooling Control (Heating MV)	Heating/Cooling Control (Heating MV)	This alarm type turns ON the alarm when the manipulated variable (MV) is lower than the alarm value (X).
			Always ON	
17	MV absolute-value lower-limit alarm *9	Standard Control	Standard Control	This alarm type turns ON the alarm when the manipulated variable (MV) is lower than the alarm value (X).
17	MV absolute-value lower-limit alarm *9	Heating/Cooling Control (Cooling MV)	Heating/Cooling Control (Cooling MV)	This alarm type turns ON the alarm when the manipulated variable (MV) is lower than the alarm value (X).
			Always ON	

*1 With set values 1, 4, and 5, the upper- and lower-limit values can be set independently for each alarm type, and are expressed as "L" and "H."

*2 Set value: 1, Upper- and lower-limit alarm

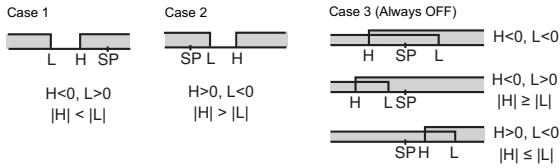

*3 Set value: 4, Upper- and lower-limit range

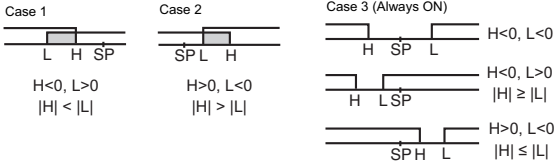

- *4 Set value: 5, Upper- and lower-limit with standby sequence For Upper- and Lower-Limit Alarm Described Above at *2
 - In cases 1 and 2 above, the alarm is always OFF if the upper- and lower-limit hysteresis overlaps.
 - In case 3, the alarm is always OFF.
- *5 Set value: 5, Upper- and lower-limit alarm with standby sequence The alarm is always OFF if upper- and lower-limit hysteresis overlaps.
- *6 Refer to the *E5□C Digital Temperature Controllers User's Manual* (Cat. No. H174) for information on the operation of the standby sequence.
- *7 Refer to the *E5□C Digital Temperature Controllers User's Manual* (Cat. No. H174) for information on the LBA.
- *8 Refer to the *E5□C Digital Temperature Controllers User's Manual* (Cat. No. H174) for information on the PV change rate alarm.
- *9 When heating/cooling control is performed, the MV absolute-value upper-limit alarm functions only for the heating operation and the MV absolute-value lower-limit alarm functions only for the cooling operation.

Characteristics

Indication accuracy (when mounted individually, ambient temperature of 23°C)	Thermocouple: ($\pm 0.3\%$ of indication value or $\pm 1^\circ\text{C}$, whichever is greater) ± 1 digit max. *1 Platinum resistance thermometer: ($\pm 0.2\%$ of indication value or $\pm 0.8^\circ\text{C}$, whichever is greater) ± 1 digit max. Analog input: $\pm 0.2\%$ FS ± 1 digit max. CT input: $\pm 5\%$ FS ± 1 digit max.	
Simple transfer output accuracy	$\pm 0.3\%$ FS max.*2	
Influence of temperature *3	Thermocouple input (R, S, B, C/W, PL II): ($\pm 1\%$ of indication value or $\pm 10^\circ\text{C}$, whichever is greater) ± 1 digit max. Other thermocouple input: ($\pm 1\%$ of indication value or $\pm 4^\circ\text{C}$, whichever is greater) ± 1 digit max. *4	
Influence of voltage *3	Platinum resistance thermometer: ($\pm 1\%$ of PV or $\pm 2^\circ\text{C}$, whichever is greater) ± 1 digit max. Analog input: $\pm 1\%$ FS ± 1 digit max.	
Influence of EMS. (at EN 61326-1)	CT input: $\pm 5\%$ FS ± 1 digit max.	
Installation influence	R, S, B, W, or PLII thermocouple: ($\pm 1\%$ of PV or $\pm 10^\circ\text{C}$, whichever is greater) ± 1 digit max. Other thermocouple: ($\pm 1\%$ of PV or $\pm 4^\circ\text{C}$, whichever is greater) ± 1 digit max. *4	
Input sampling period	50 ms	
Hysteresis	Temperature input: 0.1 to 999.9°C or °F (in units of 0.1°C or °F) Analog input: 0.01% to 99.99% FS (in units of 0.01% FS)	
Proportional band (P)	Temperature input: 0.1 to 999.9°C or °F (in units of 0.1°C or °F) Analog input: 0.1% to 999.9% FS (in units of 0.1% FS)	
Integral time (I)	0 to 9999 s (in units of 1 s), 0.0 to 999.9 s (in units of 0.1 s) *5	
Derivative time (D)	0 to 9999 s (in units of 1 s), 0.0 to 999.9 s (in units of 0.1 s) *5	
Proportional band (P) for cooling	Temperature input: 0.1 to 999.9°C or °F (in units of 0.1°C or °F) Analog input: 0.1% to 999.9% FS (in units of 0.1% FS)	
Integral time (I) for cooling	0 to 9999 s (in units of 1 s), 0.0 to 999.9 s (in units of 0.1 s) *5	
Derivative time (D) for cooling	0 to 9999 s (in units of 1 s), 0.0 to 999.9 s (in units of 0.1 s) *5	
Control period	0.1, 0.2, 0.5, 1 to 99 s (in units of 1 s)	
Manual reset value	0.0% to 100.0% (in units of 0.1%)	
Alarm setting range	-1,999 to 9,999 (decimal point position depends on input type)	
Influence of signal source resistance	Thermocouple: $0.1^\circ\text{C}/\Omega$ max. (100 Ω max.), Platinum resistance thermometer: $0.1^\circ\text{C}/\Omega$ max. (10 Ω max.)	
Insulation resistance	20 M Ω min. (at 500 VDC)	
Dielectric strength	3,000 VAC, 50/60 Hz for 1 min between terminals of different charge	
Vibration	Malfunction	10 to 55 Hz, 20 m/s ² for 10 min each in X, Y and Z directions
	Resistance	10 to 55 Hz, 20 m/s ² for 2 hr each in X, Y, and Z directions
Shock	Malfunction	100 m/s ² , 3 times each in X, Y, and Z directions
	Resistance	300 m/s ² , 3 times each in X, Y, and Z directions
Weight	Main unit: Approx. 80 g, Models with Screw Terminal Unit: Approx. 40 g, Models with Push-In Plus Terminal Unit: Approx. 40 g	
Degree of protection	Main unit: IP20, Terminal unit: IP00	
Memory protection	Non-volatile memory (number of writes: 1,000,000 times)	
Standards	Approved standards	cULus: UL 61010-1/CSA C22.2 No.61010-1, Korean wireless regulations (Radio law: KC Mark) (Some models only.) *6, Lloyd's standards (E5DC-800 only) *7
	Conformed standards	EN 61010-1 (IEC 61010-1), RCM
EMC	EMI: Radiated Interference Electromagnetic Field Strength: Noise Terminal Voltage: EMS: ESD Immunity: Electromagnetic Field Immunity: Burst Noise Immunity: Conduction Disturbance Immunity: Surge Immunity: Voltage Dip/Interrupting Immunity:	EN61326-1 *8 EN55011 Group 1, class A EN55011 Group 1, class A EN61326-1 *8 EN61000-4-2 EN61000-4-3 EN61000-4-4 EN61000-4-6 EN61000-4-5 EN61000-4-11

*1 The indication accuracy of K thermocouples in the -200 to $1,300^\circ\text{C}$ range, T and N thermocouples at a temperature of -100°C or less, and U and L thermocouples at any temperature is $\pm 2^\circ\text{C} \pm 1$ digit max. The indication accuracy of B thermocouples at a temperature of 400°C max. is not specified. The indication accuracy of B thermocouples at a temperature of 400 to 800°C is $\pm 3^\circ\text{C}$ max.

The indication accuracy of R and S thermocouples at a temperature of 200°C max. is $\pm 3^\circ\text{C} \pm 1$ digit max. The indication accuracy of C/W thermocouples is ($\pm 0.3\%$ of PV or $\pm 3^\circ\text{C}$, whichever is greater) ± 1 digit max.

The indication accuracy of PLII thermocouples is ($\pm 0.3\%$ of PV or $\pm 2^\circ\text{C}$, whichever is greater) ± 1 digit max.

*2 However, the precision between 0 and 4 mA for a 0 to 20 mA output is $\pm 1\%$ FS max.

*3 Ambient temperature: -10 to 23 to 55°C , Voltage range: -15% to 10% of rated voltage

*4 K thermocouple at -100°C max: $\pm 10^\circ\text{C}$ max.

*5 The unit is determined by the setting of the Integral/Derivative Time Unit parameter.

*6 Refer to your OMRON website for the most recent information on applicable models.

*7 Refer to information on maritime standards in *Shipping Standards* on page 65 for compliance with Lloyd's Standards.

*8 Industrial electromagnetic environment (EN/IEC 61326-1 Table 2)

Communications Specifications

Transmission line connection method	RS-485: Multidrop
Communications	RS-485 (two-wire, half-duplex)
Synchronization method	Start-stop synchronization
Protocol	CompoWay/F or Modbus
Baud rate *1	9,600, 19,200, 38,400, or 57,600 bps
Transmission code	ASCII
Data bit length *1	7 or 8 bits
Stop bit length *1	1 or 2 bits
Error detection	Vertical parity (none, even, or odd) Block check character (BCC) with CompoWay/F or CRC-16 with Modbus *2
Flow control	None
Interface	RS-485
Retry function	None
Communications buffer	217 bytes
Communications response wait time	0 to 99 ms Default: 20 ms

- *1 The baud rate, data bit length, stop bit length, and vertical parity can be individually set using the Communications Setting Level.
*2 Modbus is a registered trademark of Schneider Electric.

Communications Functions

Program-less communications *1	You can use the memory in the PLC to read and write E5□C parameters, start and stop operation, etc. The E5□C automatically performs communications with the PLC. No communications programming is required. Number of connected Digital Temperature Controllers: 32 max. (Up to 16 for the FX Series) Applicable PLCs: OMRON PLCs CS Series, CJ Series, CP Series, NJ Series, or NX1P MELSEC Q Series, L Series, FX3 Series, or iQ-R Series KEYENCE PLCs KEYENCE KV Series
Component Communications *1	When Digital Temperature Controllers are connected, set points and RUN/STOP commands can be sent from the Digital Temperature Controller that is set as the master to the Digital Temperature Controllers that are set as slaves. Slope and offsets can be set for the set point. Number of connected Digital Temperature Controllers: 32 max. (including master)
Copying *2	When Digital Temperature Controllers are connected, the parameters can be copied from the Digital Temperature Controller that is set as the master to the Digital Temperature Controllers that are set as slaves.

MELSEC is a registered trademark of Mitsubishi Electric Corporation.
KEYENCE is a registered trademark of Keyence Corporation.

- *1 A Temperature Controller with version 2.1 or higher is required for the FX Series or the KV Series.
*2 Both the programless communications and the component communications support the copying.

Current Transformer (Order Separately) Ratings

	E54-CT1 E54-CT3	E54-CT1L E54-CT3L
Dielectric strength	1,000 VAC for 1 min	1,500 VAC for 1 min
Vibration resistance	50 Hz, 98 m/s ²	
Weight	E54-CT1: Approx. 11.5 g, E54-CT3: Approx. 50 g	E54-CT1: Approx. 14 g, E54-CT3: Approx. 57 g
Accessories	E54-CT3 Only Armatures (2) Plugs (2)	None

Heater Burnout Alarms and SSR Failure Alarms

CT input (for heater current detection)	Models with detection for single-phase heaters: 1 input
Maximum heater current	50 A AC
Input current indication accuracy	±5% FS ±1 digit max.
Heater burnout alarm setting range *1	0.1 to 49.9 A (in units of 0.1 A) Minimum detection ON time: 100 ms *3
SSR failure alarm setting range *2	0.1 to 49.9 A (in units of 0.1 A) Minimum detection OFF time: 100 ms *4

- *1 For heater burnout alarms, the heater current will be measured when the control output is ON, and the output will turn ON if the heater current is lower than the set value (i.e., heater burnout detection current value).
*2 For SSR failure alarms, the heater current will be measured when the control output is OFF, and the output will turn ON if the heater current is higher than the set value (i.e., SSR failure detection current value).
*3 The value is 30 ms for a control period of 0.1 s or 0.2 s.
*4 The value is 35 ms for a control period of 0.1 s or 0.2 s.

Electrical Life Expectancy Curve for Control Output Relay (Reference Values)

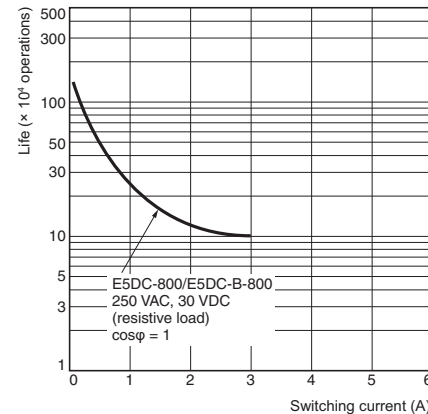

External Connections

E5DC-800 (Models with Screw Terminal Blocks)

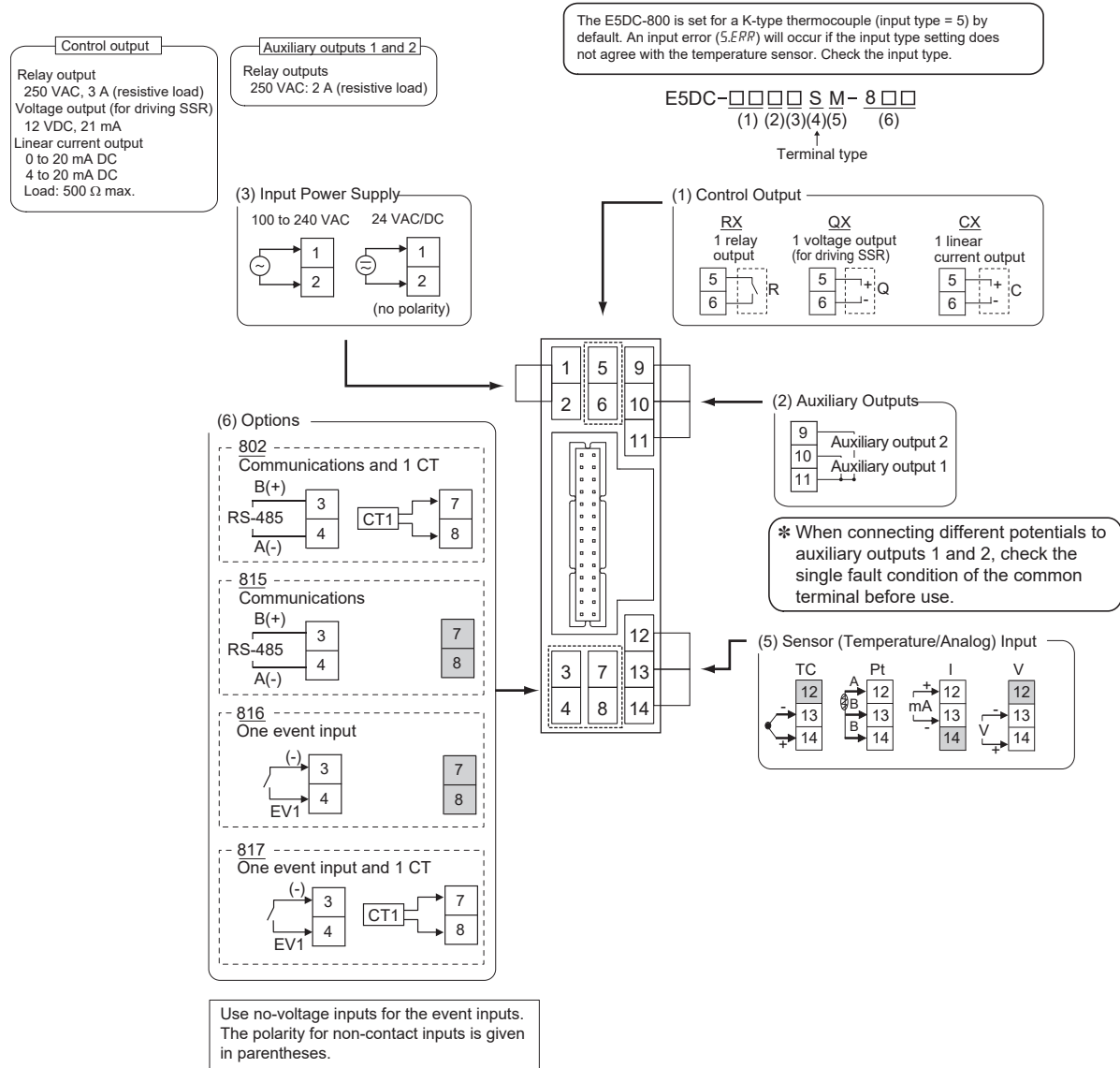

- Note:**
1. The application of the terminals depends on the model.
 2. Do not wire the terminals that are shown with a gray background.
 3. When complying with EMC standards, the cable that connects the sensor must be 30 m or less. If the cable length exceeds 30m, compliance with EMC standards will not be possible.
 4. Connect M3 crimped terminals.
 5. Due to UL Listing requirements, use the E54-CT1L or E54-CT3L Current Transformer with the factory wiring (internal wiring). Use a UL category XOBA or XOBA7 current transformer that is UL Listed for field wiring (external wiring) and not the factory wiring (internal wiring).
 6. The terminal layout is different than models with Push-In Plus terminal blocks. Check the terminal arrangement before wiring.

E5DC-800/E5DC-B-800

E5DC-B-800 (Models with Push-In Plus Terminal Blocks)

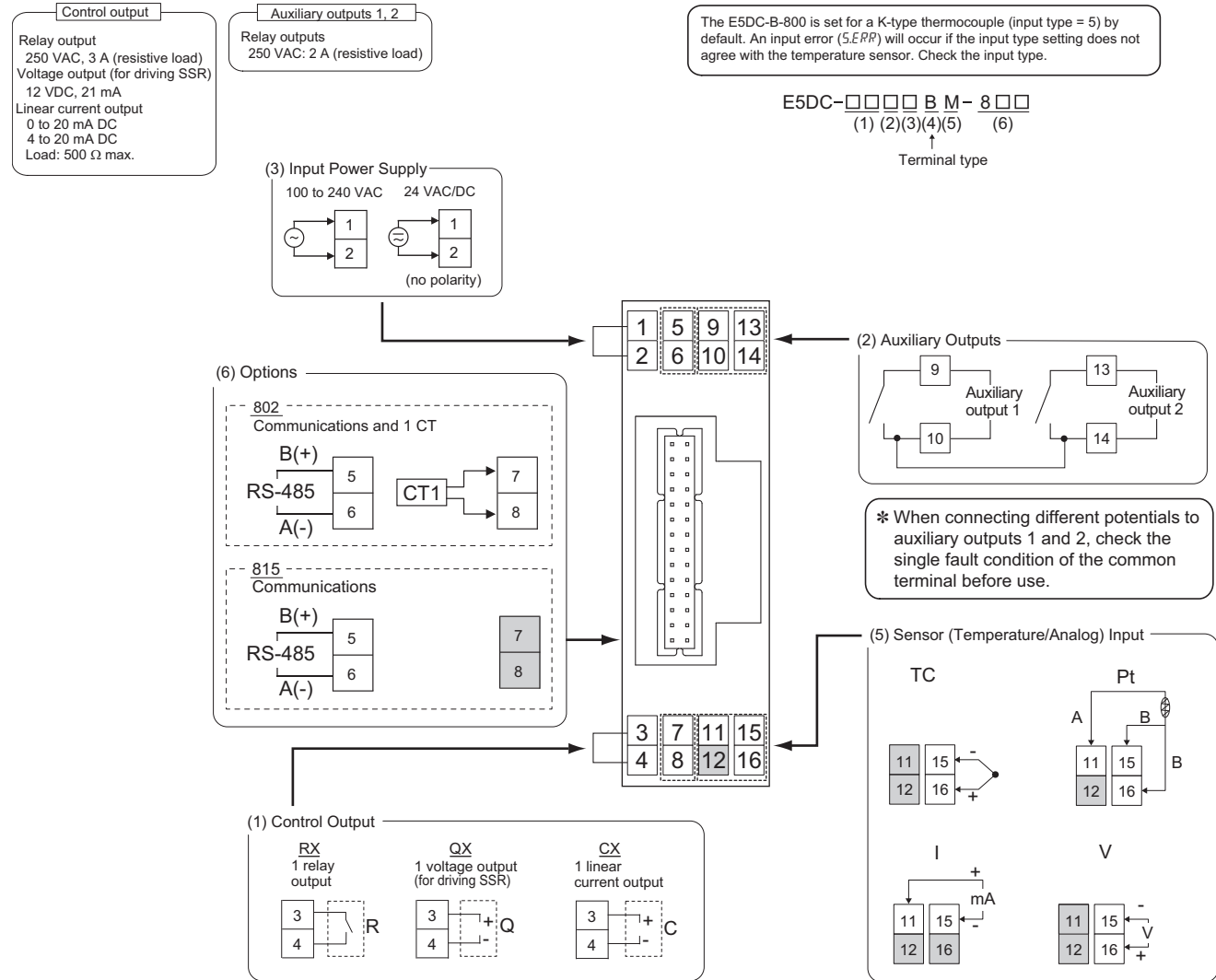

- Note:**
- The application of the terminals depends on the model.
 - Do not wire the terminals that are shown with a gray background.
 - When complying with EMC standards, the cable that connects the sensor must be 30 m or less. If the cable length exceeds 30m, compliance with EMC standards will not be possible.
 - Refer to Wiring Precautions for E5□C-B-800 (Controllers with Push-In Plus Terminal Blocks) on page 71 for wire specifications and wiring methods.
 - Due to UL Listing requirements, use the E54-CT1L or E54-CT3L Current Transformer with the factory wiring (internal wiring). Use a UL category XOBA or XOBA7 current transformer that is UL Listed for field wiring (external wiring) and not the factory wiring (internal wiring).
 - The terminal layout is different than models with screw terminal blocks. Check the terminal arrangement before wiring.
 - The event input specification main unit is not used with models with Push-In Plus terminal blocks.

Isolation/Insulation Block Diagrams

E5DC-800

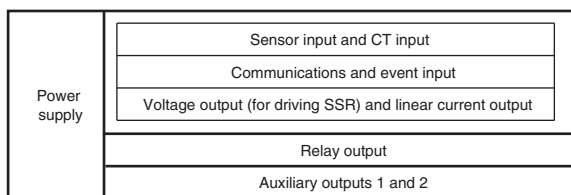

: Reinforced insulation
 : Functional insulation

Note: Auxiliary outputs 1 and 2 are not insulated.

E5DC-B-800

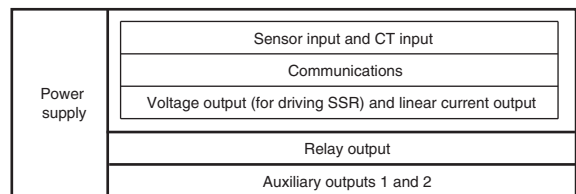

: Reinforced insulation
 : Functional insulation

Note: Auxiliary outputs 1 to 2 are not insulated.

Nomenclature

E5DC-800
E5DC-B-800

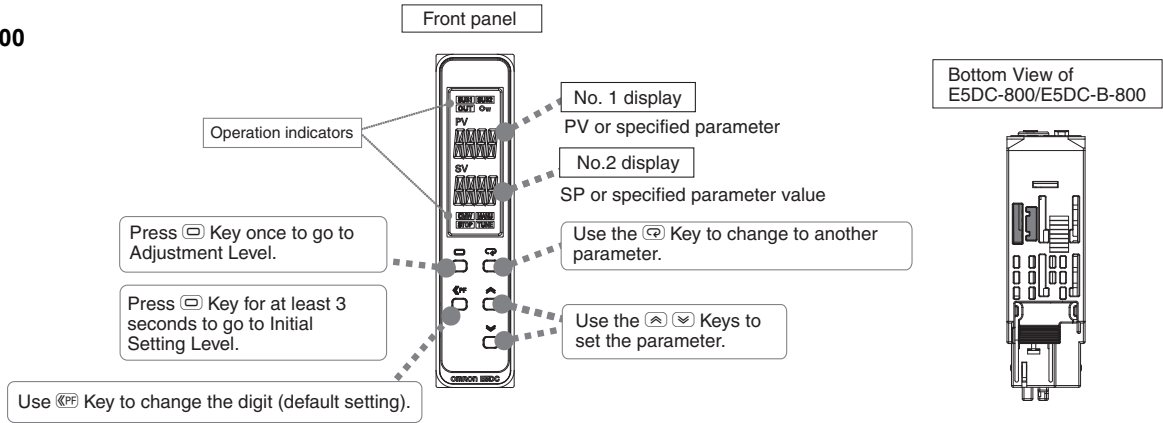

E5DC-800/E5DC-B-800

Dimensions

(Unit: mm)

Controllers

E5DC-800



The above figure shows the Terminal Unit attached to the Main Unit.

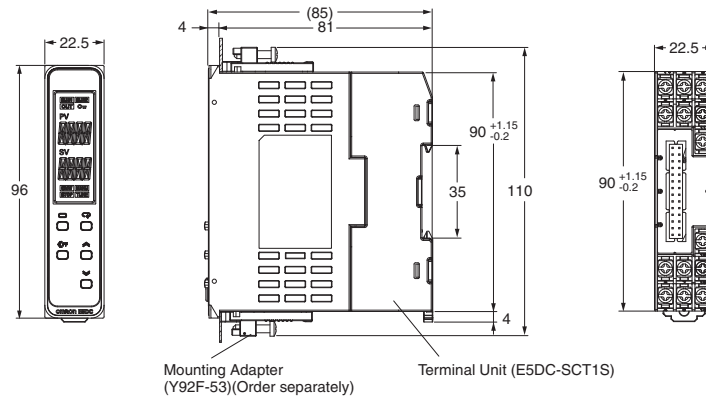

E5DC-B-800



The above figure shows the Push-In Plus Terminal Unit attached to the Main Unit.

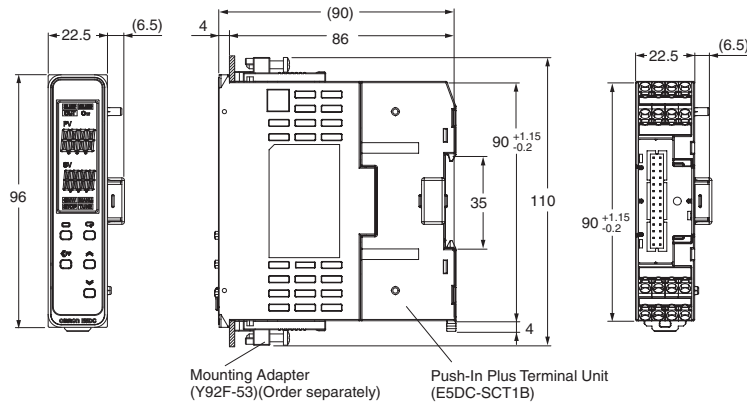

Mounted Separately

Two-Unit Mounting

Group Mounted

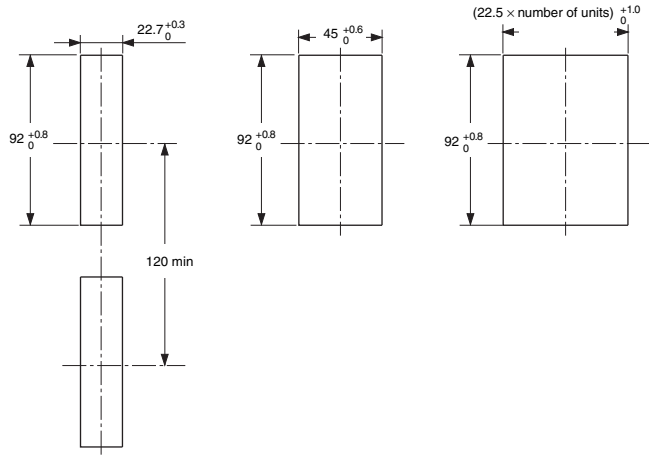

- Recommended panel thickness is 1 to 8 mm.
- Group mounting is not possible in the vertical direction. (Maintain the specified mounting space between Controllers.)
- When two or more Digital Temperature Controllers are mounted, make sure that the surrounding temperature does not exceed the allowable operating temperature specified in the specifications.

Accessories (Order Separately)

Terminal Unit
E5DC-SCT1S

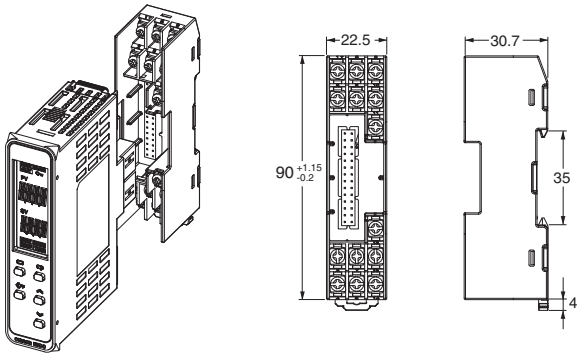

Push-In Plus Terminal Unit
E5DC-SCT1B

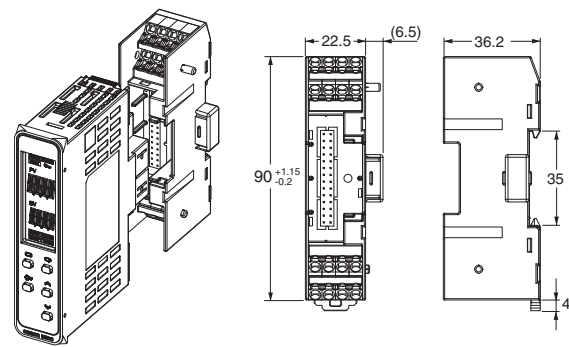

● Current Transformers

E54-CT1

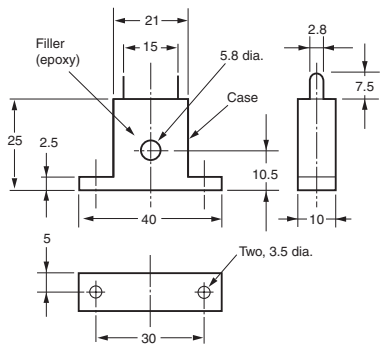
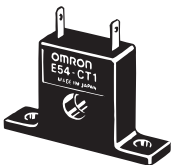

Thru-current (I_o) vs. Output Voltage (E_o)
(Reference Values)
E54-CT1 or E54-CT1L

Maximum continuous heater current: 50 A (50/60 Hz)
Number of windings: 400±2
Winding resistance: 18±2 Ω

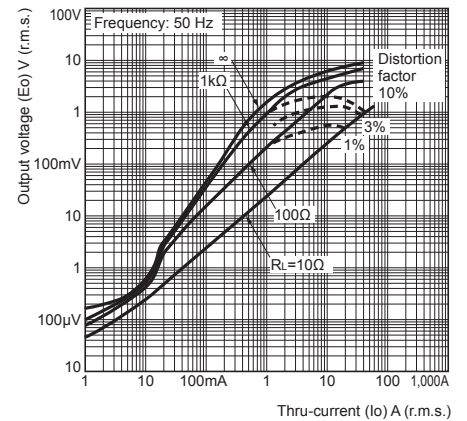

E54-CT1L

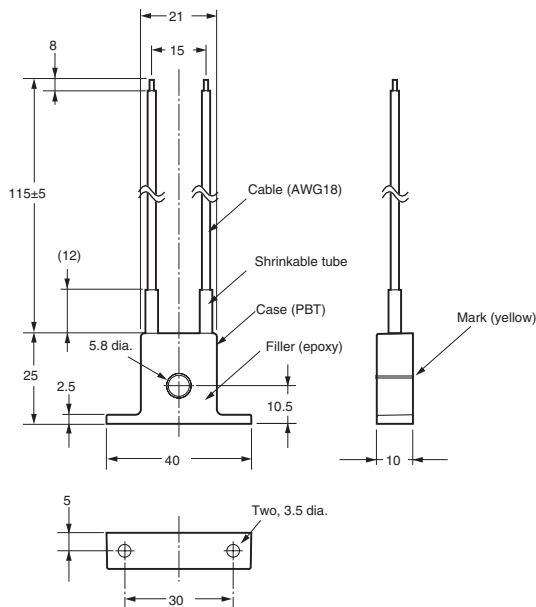
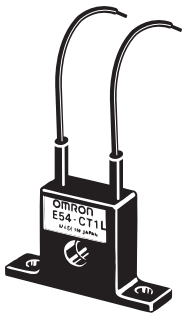

E54-CT3

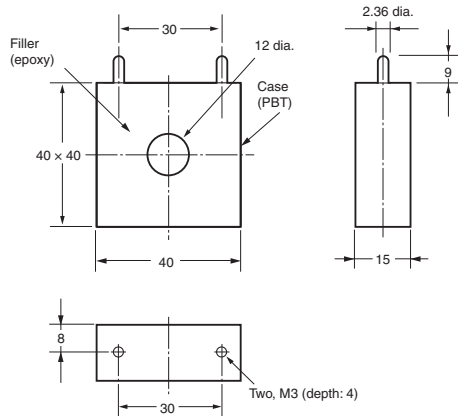

E54-CT3 Accessories

• Armature

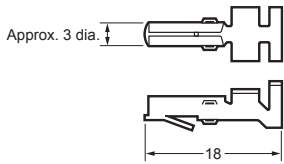

Connection Example

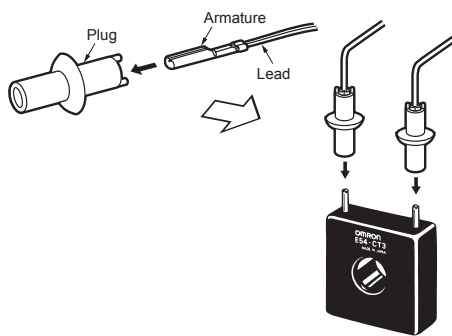

• Plug

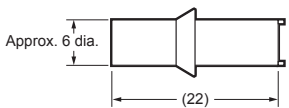

Thru-current (I_o) vs. Output Voltage (E_o) (Reference Values) E54-CT3 or E54-CT3L

Maximum continuous heater current: 120 A (50/60 Hz)
(Maximum continuous heater current for an OMRON Digital Temperature Controller is 50 A.)

Number of windings: 400±2

Winding resistance: 8±0.8 Ω

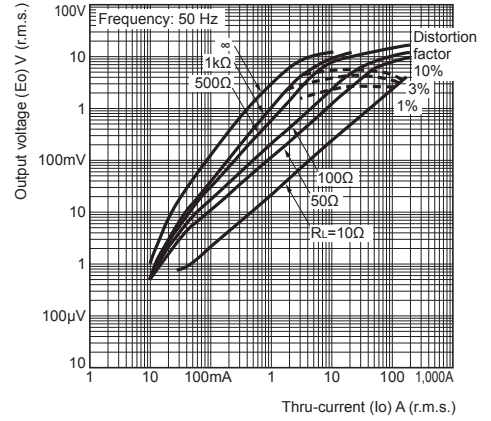

E54-CT3L

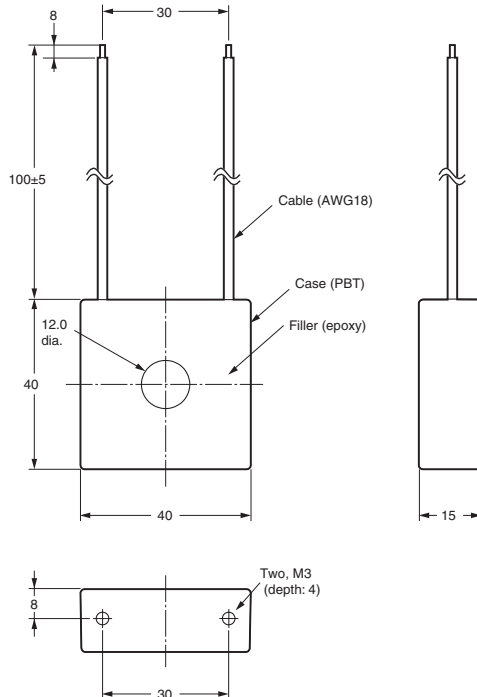

● **Mounting Adapters**
Y92F-53 (Two included.)

This accessory is not included with the product. Order it separately to mount the product to a panel.

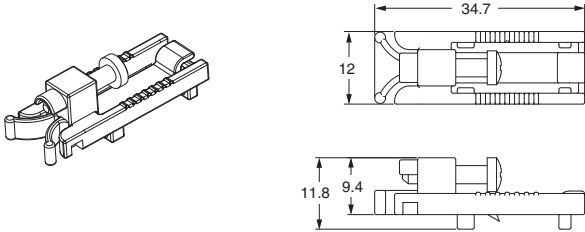

● **Short Bars**
Y92S-P11 (Four included.)

Use this product to connect between terminals (for power supplies, communications, etc.) when you use multiple E5DC-800 Controllers.

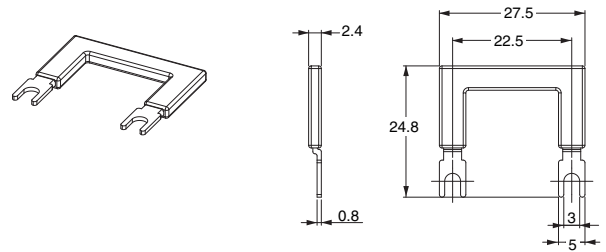

● **End Plate**
PFP-M

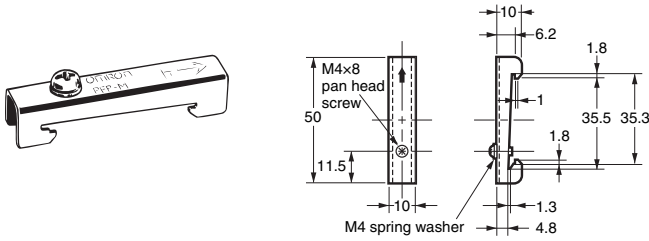

● **DIN Tracks**
PFP-100N
PFP-50N

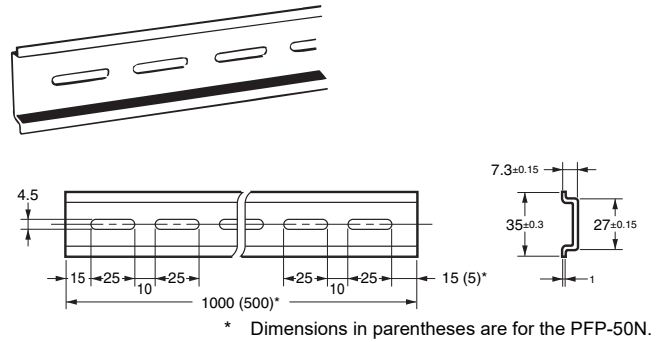

● **Spacer**
PFP-S

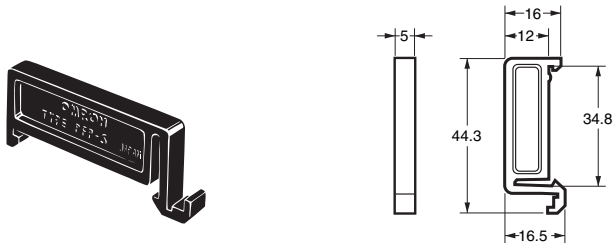

● **Unit Labels**
Y92S-L2

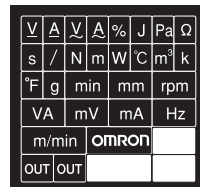

The Unit Labels for the Digital Panel Meter are used. Use either the °C or °F label from the sheet.

● **End Cover**
Y92F-54 (Two included.)

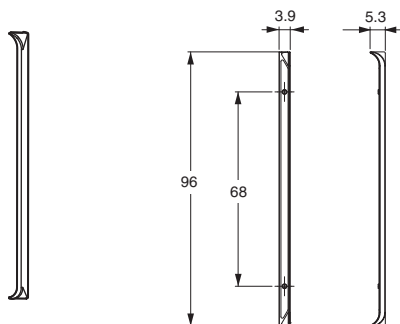

Use the End Cover when you mount the E5DC-800/ E5DC-B-800 to a panel to hide the gap between the Controller and the panel.

E5DC-800/E5DC-B-800

Connector Cover

E53-COV26

Male connector cover

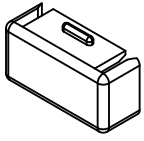

Female connector cover

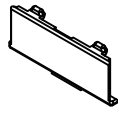

E5DC-B-800 Push-In Plus Terminal Units are mounted with both a male and female connector cover (E53-COV26). Order the connector cover separately if it becomes lost or damaged.

Operation

Setting Levels Diagram

This diagram shows all of the setting levels. To move to the advanced function setting level and calibration level, you must enter passwords. Some parameters are not displayed depending on the protect level setting and the conditions of use. Control stops when you move from the operation level to the initial setting level.

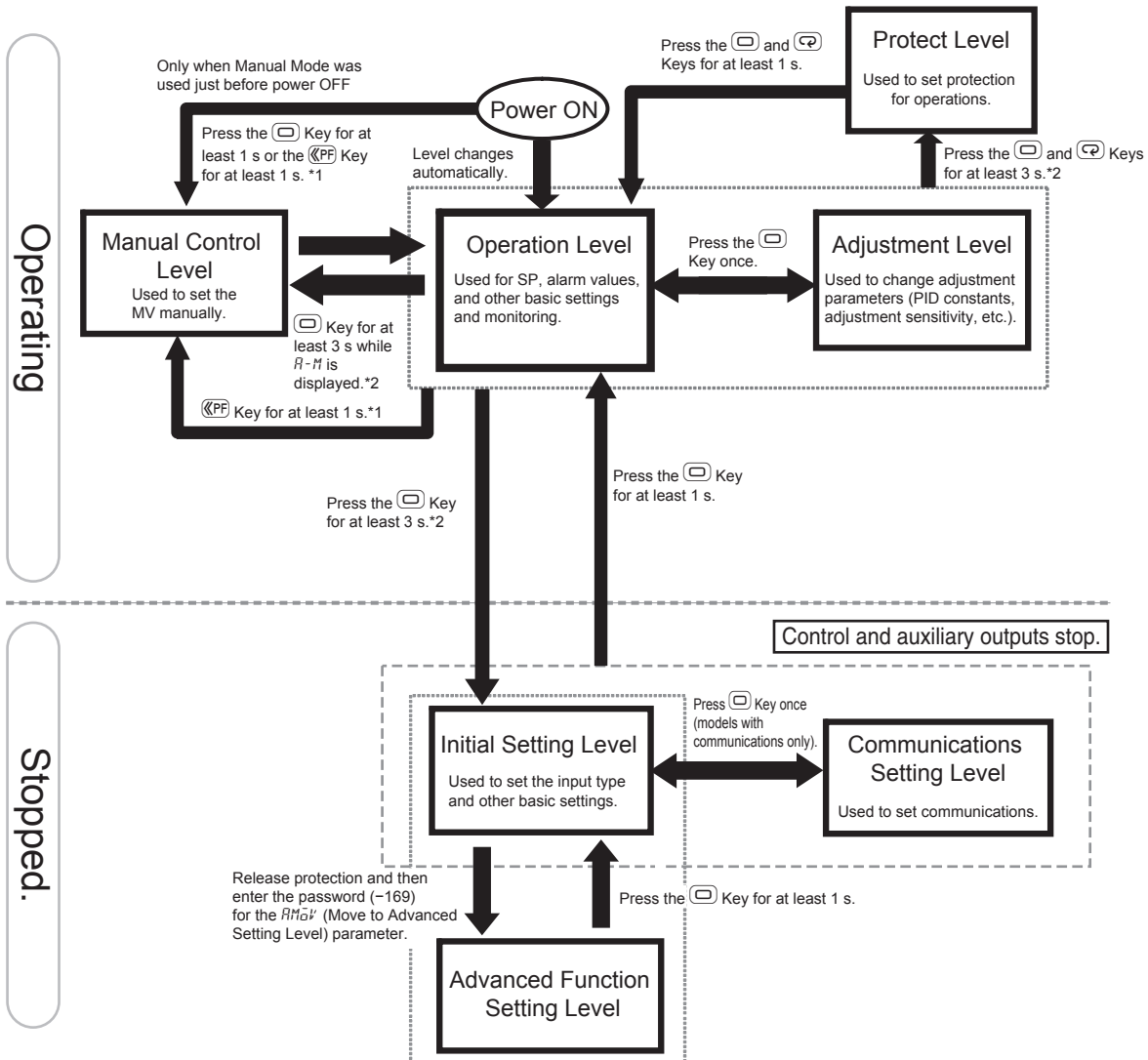

*1. Set the PF Setting parameter to R-M (Auto/Manual).
 *2. The No. 1 display will flash when the keys are pressed for 1 s or longer.

Error Displays (Troubleshooting)

When an error occurs, the No. 1 display or No. 2 display shows the error code.
Take necessary measure according to the error code, referring the following table.

Display	Name	Meaning	Action	Operation
S.ERR	Input error	<p>The input value exceeded the control range.* The input type is not set correctly. The sensor is disconnected or short-circuited. The sensor is not wired correctly. The sensor is not wired.</p> <p>* Control Range Temperature resistance thermometer or thermocouple input: SP Lower Limit - 20°C to SP Upper Limit + 20°C (SP Lower Limit - 40°F to SP Upper Limit + 40°F) ESIB input: Same as specified input range. Analog input: Scaling range -5% to 105%</p>	<p>Check the wiring for input to be sure it is wired correctly, not broken, and not shorted. Also check the input type. If there are no problems in the wiring or input type settings, cycle the power supply. If the display remains the same, replace the Digital Temperature Controller. If the display is restored to normal, then the probable cause is external noise affecting the control system. Check for external noise.</p> <p>Note: For a temperature resistance thermometer, the input is considered disconnected if the A, B, or B' line is broken.</p>	<p>After the error occurs and it is displayed, the alarm output will operate as if the upper limit was exceeded. It will also operate as if transfer output exceeded the upper limit. If an input error is assigned to a control output or auxiliary output, the output will turn ON when the input error occurs. The error message will appear in the display for the PV.</p> <p>Note: 1. The heating and cooling control outputs will turn OFF. 2. When the manual MV, MV at stop, or MV at error is set, the control output is determined by the set value.</p>
CCCC	Display range exceeded	Below -1,999	-	Control continues and operation is normal. The value will appear in the display for the PV. Refer to the E5□C Digital Controllers User's Manual (Cat. No. H174) for information on the controllable range.
3333		Above 9,999		
E333	A/D converter error	There is an error in the internal circuits.	<p>First, cycle the power supply. If the display remains the same, the controller must be repaired. If the display is restored to normal, then a probable cause can be external noise affecting the control system. Check for external noise.</p>	The control outputs, auxiliary outputs, and transfer outputs turn OFF. (A current output will be approx. 0 mA and a linear voltage output will be approx. 0V.)
E111	Memory error	There is an error in the internal memory operation.	<p>First, cycle the power supply. If the display remains the same, the controller must be repaired. If the display is restored to normal, then a probable cause can be external noise affecting the control system. Check for external noise.</p>	The control outputs, auxiliary outputs, and transfer outputs turn OFF. (A current output will be approx. 0 mA and a linear voltage output will be approx. 0V.)
FFFF	Overcurrent	This error is displayed when the peak current exceeds 55.0 A.	-	Control continues and operation is normal. The error message will appear for the following displays. Heater Current Value 1 Monitor Leakage Current Value 1 Monitor
LE1 LER1	HB or HS alarm	If there is a HB or HS alarm, the No. 1 display will flash in the relevant setting level.	-	The No. 1 display for the following parameter flashes in Operation Level or Adjustment Level. Heater Current Value 1 Monitor Leakage Current Value 1 Monitor However, control continues and operation is normal.
----	Potentiometer Input Error (Position-proportional Models Only)	<p>"----" will be displayed for the Valve Opening Monitor parameter if any of the following error occurs.</p> <ul style="list-style-type: none"> Motor calibration has not been performed. The wiring of the potentiometer is incorrect or broken. The potentiometer input value is incorrect (e.g., the input is out of range or the potentiometer has failed). 	Check for the above errors.	Close control: The control output is OFF or the value that is set for the MV at PV Error parameter is output. Floating control: Operation will be normal.

Operation

Parameters

The following pages describe the parameters set in each level. Pressing the \square (Mode) Key at the last parameter in each level returns to the top parameter in that level. Some parameters may not be displayed depending on the model and other settings.

000: Indicates items that can be used only with the E5□C-□-0□□.

800: Indicates items that can be used only with the E5□C-□-8□□.

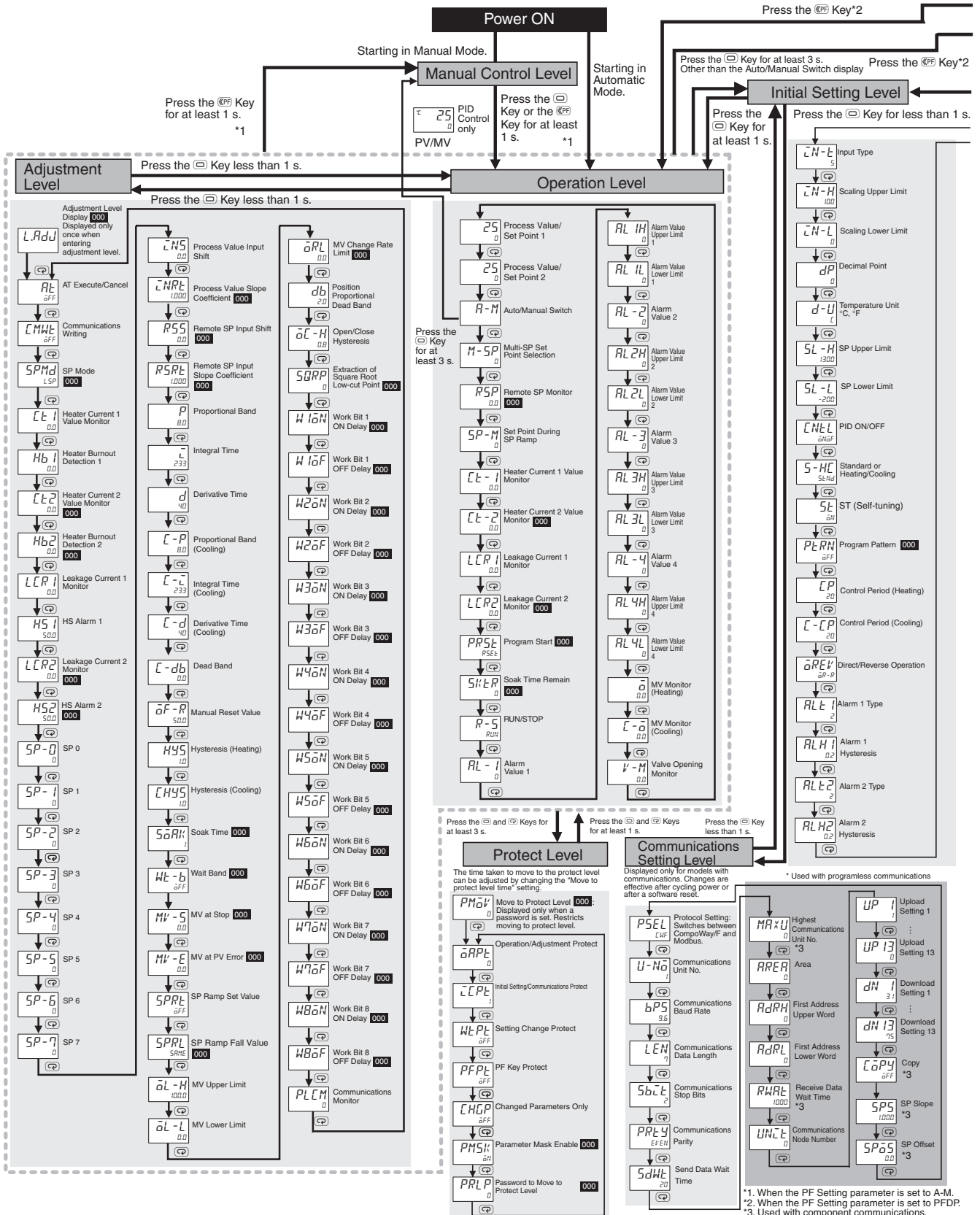

*1. When the PF Setting parameter is set to A-M.
 *2. When the PF Setting parameter is set to PFDP.
 *3. Used with component communications.

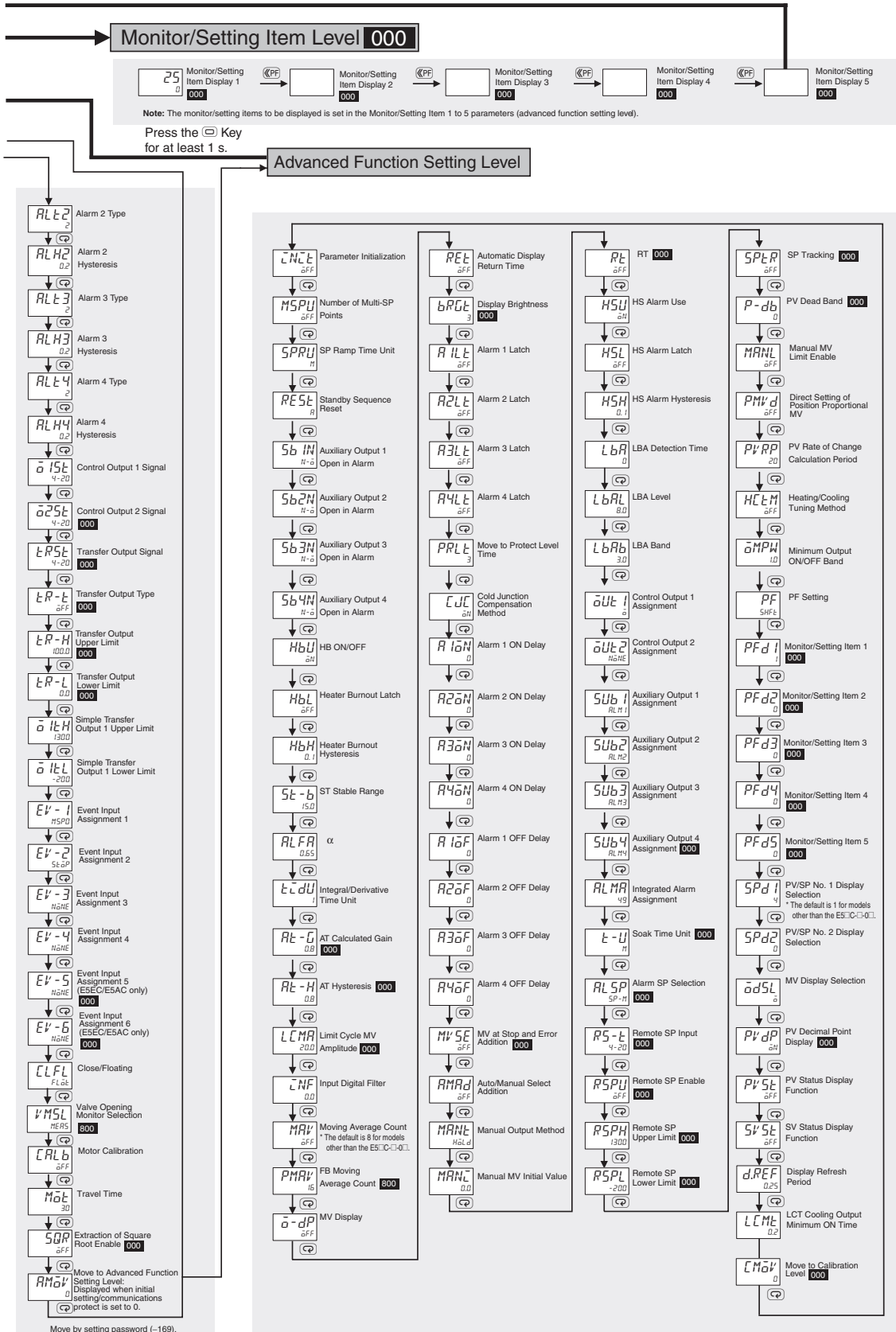





Safety Precautions

● Be sure to read the precautions for all E5CC-800/E5CC-B-800/E5CC-U-800/E5EC-800/E5EC-B-800/E5AC-800/E5DC-800/E5DC-B-800 models in the website at: <http://www.ia.omron.com/>.

Warning Indications

 CAUTION	Indicates a potentially hazardous situation which, if not avoided, may result in minor or moderate injury or in property damage.
Precautions for Safe Use	Supplementary comments on what to do or avoid doing, to use the product safely.
Precautions for Correct Use	Supplementary comments on what to do or avoid doing, to prevent failure to operate, malfunction or undesirable effect on product performance.

Meaning of Product Safety Symbols

	Used to warn of the risk of electric shock under specific conditions.
	Used for general prohibitions for which there is no specific symbol.
	Used to indicate prohibition when there is a risk of minor injury from electrical shock or other source if the product is disassembled.
	Used for general CAUTION, WARNING, or DANGER precautions for which there is no specified symbol. (This symbol is also used as the alerting symbol, but shall not be used in this meaning on the product.)
	Used for general mandatory action precautions for which there is no specified symbol.

CAUTION

Do not touch the terminals while power is being supplied. Doing so may occasionally result in minor injury due to electric shock. 

Electric shock may occur. Do not touch any cables or connectors with wet hands. 

Minor electric shock, fire, or malfunction may occasionally occur. Do not allow any metal, conductors, chips from mounting work, or water to enter the interior of the Digital Controller, the Setting Tool port, or between the pins on the Setting Tool cable connector. 

Do not use the Digital Temperature Controller where subject to flammable or explosive gas. Otherwise, minor injury from explosion may occasionally occur. 

Not doing so may occasionally result in fire. Do not allow dirt or other foreign objects to enter the Setup Tool port or ports, or between the pins on the connectors on the Setup Tool cable. 

Minor electric shock or fire may occasionally occur. Do not use any cables that are damaged. 

Never disassemble, modify, or repair the product or touch any of the internal parts. Minor electric shock, fire, or malfunction may occasionally occur. 

CAUTION - Risk of Fire and Electric Shock
 a. This product is UL recognised *1 as Open Type Process Control Equipment. It must be mounted in an enclosure that does not allow fire to escape externally. 
 b. More than one disconnect switch may be required to de-energize the equipment before servicing the product.
 c. Signal inputs are SELV, limited energy. *2
 d. Caution: To reduce the risk of fire or electric shock, do not interconnect the outputs of different Class 2 circuits. *3

If the output relays are used past their life expectancy, contact fusing or burning may occasionally occur. Always consider the application conditions and use the output relays within their rated load and electrical life expectancy. The life expectancy of output relays varies considerably with the output load and switching conditions. 

Even if you replace only the Main Unit of the E5DC-800/E5DC-B-800 check the condition of the Terminal Unit. If corroded terminals are used, contact failure in the terminals may cause the temperature inside the Digital Controller to increase, possibly resulting in fire. If the terminals are corroded, replace the Terminal Unit as well. 

Tighten the terminal screws to the rated torque of between 0.43 and 0.58 N·m. *4
 Loose screws may occasionally result in fire. 

Set the parameters of the product so that they are suitable for the system being controlled. If they are not suitable, unexpected operation may occasionally result in property damage or accidents. 

A malfunction in the product may occasionally make control operations impossible or prevent alarm outputs, resulting in property damage. To maintain safety in the event of malfunction of the product, take appropriate safety measures, such as installing a monitoring device on a separate line. 

*1. E5CC-800, E5EC-800, E5AC-800, and E5DC-800 Controllers that were shipped through November 2013 are UL recognized.
 *2. An SELV (separated extra-low voltage) system is one with a power supply that has double or reinforced insulation between the primary and the secondary circuits and has an output voltage of 30 V r.m.s. max. and 42.4 V peak max. or 60 VDC max.
 *3. A class 2 circuit is one tested and certified by UL as having the current and voltage of the secondary output restricted to specific levels.
 *4. The specified torque is 0.5 N·m for the E5CC-U-800.

Precautions for Safe Use

Be sure to observe the following precautions to prevent malfunction or adverse affects on the performance or functionality of the product. Not doing so may occasionally result in faulty operation. Do not handle the Digital Temperature Controller in ways that exceed the ratings.

- This product is specifically designed for indoor use only. Do not use this product in the following places:
 - Places directly subject to heat radiated from heating equipment.
 - Places subject to splashing liquid or oil atmosphere.
 - Places subject to direct sunlight.
 - Places subject to dust or corrosive gas (in particular, sulfide gas and ammonia gas).
 - Places subject to intense temperature change.
 - Places subject to icing and condensation.
 - Places subject to vibration and large shocks.
- Use and store the product within the rated ambient temperature and humidity. Gang-mounting two or more Digital Temperature Controllers, or mounting Digital Temperature Controllers above each other may cause heat to build up inside the Digital Temperature Controllers, which will shorten their service life. In such a case, use forced cooling by fans or other means of air ventilation to cool down the Digital Temperature Controllers.
- To allow heat to escape, do not block the area around the Digital Temperature Controller. Do not block the ventilation holes on the Digital Temperature Controller.
- Be sure to wire properly with correct signal name and polarity of terminals.
- Use copper stranded or solid wires to connect bare wires.

Recommended Wire

Model	Wire Size	Wire Stripping length
E5□C-800 (Controllers with Screw Terminal Blocks)	AWG 24 to AWG18 (0.21 to 0.82 mm ²)	6 to 8 mm
E5CC-U-800 (Plug-in model)	AWG 24 to 14 (0.21 to 2.08 mm ²)	5 to 6 mm
E5□C-B-800 (Controllers with Push-In Plus Terminal Blocks)	0.25 to 1.5 mm ² AWG 24 to 16	Ferrules not used: 8 mm

Use the specified size of crimped terminals to wire the E5CC-800, E5EC-800, E5AC-800, E5DC-800 (models with screw terminal blocks) and E5CC-U-800 (plug-in models).

Recommended Crimped Terminal Size

Model	Wire Size
E5□C-800 (Controllers with Screw Terminal Blocks)	M3, Width: 5.8 mm max.
E5CC-U-800 (Plug-in model)	M3.5, Width: 7.2 mm max.

For the E5□C-B-800 (Push-In Plus model), connect only one wire to each terminal.

For other models, up to two wires of same size and type, or two crimp terminals, can be inserted into a single terminal.

- Do not wire the terminals that are not used.
- Use a commercial power supply for the power supply voltage input to a Digital Temperature Controller with AC input specifications. Do not use the output from an inverter as the power supply. Depending on the output characteristics of the inverter, temperature increases in the Digital Temperature Controller may cause smoke or fire damage even if the inverter has a specified output frequency of 50/60 Hz.

- To avoid inductive noise, keep the wiring for the product's terminal block away from power cables carry high voltages or large currents. Also, do not wire power lines together with or parallel to product wiring. Using shielded cables and using separate conduits or ducts is recommended. Attach a surge suppressor or noise filter to peripheral devices that generate noise (in particular, motors, transformers, solenoids, magnetic coils, or other equipment that have an inductance component). When a noise filter is used at the power supply, first check the voltage or current, and attach the noise filter as close as possible to the product. Allow as much space as possible between the product and devices that generate powerful high frequencies (high-frequency welders, high-frequency sewing machines, etc.) or surge.
- Use this product within the rated load and power supply.
- Make sure that the rated voltage is attained within two seconds of turning ON the power using a switch or relay contact. If the voltage is applied gradually, the power may not be reset or output malfunctions may occur.
- Make sure that the Digital Temperature Controller has 30 minutes or more to warm up after turning ON the power before starting actual control operations to ensure the correct temperature display.
- When executing self-tuning for the E5DC-800, turn ON power to the load (e.g., heater) at the same time as or before supplying power to the product. If power is turned ON to the product before turning ON power to the load, self-tuning will not be performed properly and optimum control will not be achieved.
- A switch or circuit breaker must be provided close to the product. The switch or circuit breaker must be within easy reach of the operator, and must be marked as a disconnecting means for this unit.
- Use a soft and dry cloth to clean the product carefully. Do not use organic solvent, such as paint thinner, benzine or alcohol to clean the product.
- Design the system (e.g., control panel) considering the 2 seconds of delay that the product's output to be set after power ON.
- The output may turn OFF when you move to the initial setting level. Take this into consideration when performing control operations.
- The number of non-volatile memory write operations is limited. Therefore, use RAM write mode when frequently overwriting data during communications or other operations.
- Always touch a grounded piece of metal before touching the Digital Temperature Controller to discharge static electricity from your body.
- Use suitable tools when taking the Digital Temperature Controller apart for disposal. Sharp parts inside the Digital Temperature Controller may cause injury.
- For compliance with Lloyd's standards, the E5CC-800, E5CC-B-800, E5CC-U-800, E5EC-800, E5EC-B-800, E5AC-800, and E5DC-800 must be installed under the conditions that are specified in *Shipping Standards*.
- Do not touch the external power supply terminals or other metal parts on the Digital Temperature Controller.
- Do not exceed the communications distance that is given in the specifications and use the specified communications cable. Refer to the *E5□C Digital Temperature Controllers User's Manual* (Cat. No. H174) for information on the communications distances and cables for the E5□C.
- Do not bend the communications cables past their natural bending radius. Do not pull on the communications cables.
- Connectors may be damaged if they are inserted with excessive force. When connecting a connector, always make sure that it is oriented correctly. Do not force the connector if it does not connect smoothly.
- For the E5DC-800/E5DC-B-800, when you attach the Main Unit to the Terminal Unit, make sure that the hooks on the Main Unit are securely inserted into the Terminal Unit.
- For the E5CC-U-800, when you attach the Main Unit to the socket, make sure that the hooks on the socket are securely inserted into the Main Unit.
- Install the DIN Track vertically to the ground.

28. For the E5DC-800/E5DC-B-800, always turn OFF the power supply before connecting the Main Unit to or disconnecting the Main Unit from the Terminal Unit, and never touch nor apply shock to the terminals or electronic components. When connecting or disconnecting the Main Unit, do not allow the electronic components to touch the case.
29. Observe the following precautions when you wire the E5□C-B-800.
- Always follow the wiring instructions provided in *Wiring Precautions for E5□C-B-800 (Controllers with Push-In Plus Terminal Blocks)* on page 71.
 - Do not wire anything to the release holes.
 - Do not tilt or twist a flat-blade screwdriver while it is inserted into a release hole on the terminal block. The terminal block may be damaged.
 - Insert a flat-blade screwdriver into the release holes at an angle. The terminal block may be damaged if you insert the screwdriver straight in.
 - Do not allow the flat-blade screwdriver to fall out while it is inserted into a release hole.
 - Do not bend a wire past its natural bending radius or pull on it with excessive force. Doing so may cause the wire disconnection.
 - Do not use crossover wiring for the E5CC-B-800/E5EC-B-800 except for the input power supply and communications. Do not use crossover wiring for the E5DC-B-800.

Shipping Standards

The E5CC-800, E5CC-B-800, E5CC-U-800, E5EC-800, E5EC-B-800, E5AC-800, and E5DC-800 comply with Lloyd's standards. When applying the standards, the following installation and wiring requirements must be met in the application. Also insert the Waterproof Packing on the backside of the front panel.

Application Conditions

●Installation Location

The E5CC-800, E5CC-B-800, E5CC-U-800, E5EC-800, E5EC-B-800, E5AC-800, and E5DC-800 comply with installation category ENV1 and ENV2 of Lloyd's standards. Therefore, they must be installed in a location equipped with air conditioning. They cannot be used on the bridge or decks, or in a location subject to strong vibration.

Precautions for Correct Use

●Service Life

- Use the product within the following temperature and humidity ranges:
 Temperature: -10 to 55°C (with no icing or condensation)
 Humidity: 25% to 85%
 If the product is installed inside a control board, the ambient temperature must be kept to under 55°C, including the temperature around the product.
- The service life of electronic devices like Digital Temperature Controllers is determined not only by the number of times the relay is switched but also by the service life of internal electronic components.
 Component service life is affected by the ambient temperature: the higher the temperature, the shorter the service life and, the lower the temperature, the longer the service life. Therefore, the service life can be extended by lowering the temperature of the Digital Temperature Controller.
- When two or more Digital Temperature Controllers are mounted horizontally close to each other or vertically next to one another, the internal temperature will increase due to heat radiated by the Digital Temperature Controllers and the service life will decrease. In such a case, use forced cooling by fans or other means of air ventilation to cool down the Digital Temperature Controllers. When providing forced cooling, however, be careful not to cool down the terminals sections alone to avoid measurement errors.

●Measurement Accuracy

- When extending or connecting the thermocouple lead wire, be sure to use compensating wires that match the thermocouple types.
- When extending or connecting the lead wire of the platinum resistance thermometer, be sure to use wires that have low resistance and keep the resistance of the three lead wires the same.
- Mount the product so that it is horizontally level.
- If the measurement accuracy is low, check to see if input shift has been set correctly.

●Waterproofing

(Not applicable to the E5CC-U-800/E5DC-800/E5DC-B-800)

The degree of protection is as shown below. Sections without any specification on their degree of protection or those with IP□0 are not waterproof.

Front panel: IP66, Rear case: IP20, Terminal section: IP00

When waterproofing is required, insert the Waterproof Packing on the backside of the front panel. The degree of protection when the Waterproof Packing is used is IP66. To maintain an IP66 degree of protection, the Waterproof Packing must be periodically replaced because they may deteriorate, shrink, or harden depending on the operating environment. The replacement period will vary with the operating environment. Check the required period in the actual application. Use 3 years or sooner as a guideline.

●Operating Precautions

- When starting operation after the Digital Temperature Controller has warmed up, turn OFF the power and then turn it ON again at the same time as turning ON power for the load. (Instead of turning the Digital Temperature Controller OFF and ON again, switching from STOP mode to RUN mode can also be used.)
- Avoid using the Digital Temperature Controller in places near a radio, television set, or wireless installing. These devices can cause radio disturbances which adversely affect the performance of the Controller.

●Others

- Wiring
 When linking the units together, connect the power cable only to the unit at the left end of the linkage block. Incorrect wiring can be shorted inside the unit resulting in damage to the unit. Do not perform crossover wiring between each linkage block, or to another device. This could result in a breakdown or incorrect operation.

Prohibited Multiplex Power Input Wiring

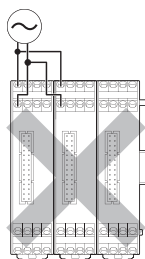

Incorrect

Prohibited Crossover Wiring

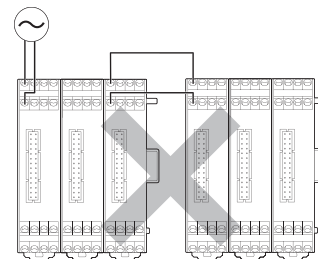

Incorrect

- When N units are linked together, the inrush current will be equal to N times that for 1 unit. Be sure to use the external fuse with the appropriate fusing characteristics, and the breaker with the appropriate tripping characteristics to ensure that the fuse does not melt and the breaker is not activated due to the inrush current. The inrush current per Unit is 30 A or less.
- Do not remove the connector cover from connectors that are not to be linked. The connector covers have been mounted on the product during shipment.
- Do not add or separate the units during power-on.

● Mounting

Mounting to a Panel

E5CC-800/E5CC-B-800/E5CC-U-800

- E5CC-800

There are two models of Terminal Covers that you can use with the E5CC-800.

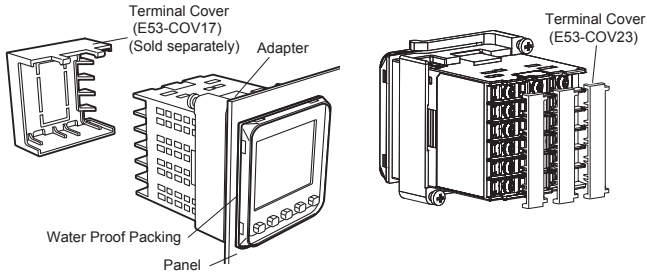

- E5CC-U-800

For the Wiring Socket for the E5CC-U-800, purchase the P2CF-11 or P3GA-11 separately.

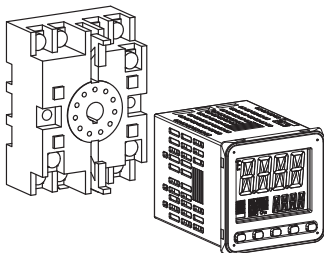

1. For waterproof mounting, waterproof packing must be installed on the Digital Temperature Controller. Waterproofing is not possible when group mounting several Digital Temperature Controllers. Waterproof packing is not necessary when there is no need for the waterproofing function. The E5CC-U-800 cannot be waterproofed even if the Waterproof Packing is inserted.
2. Insert the E5CC-800/E5CC-B-800/E5CC-U-800 into the mounting hole in the panel.
3. Push the adapter from the terminals up to the panel, and temporarily fasten the E5CC-800/E5CC-B-800/E5CC-U-800.
4. Tighten the two fastening screws on the adapter. Alternately tighten the two screws little by little to maintain a balance. Tighten the screws to a torque of 0.29 to 0.39 N·m.

E5EC-800/E5EC-B-800/E5AC-800

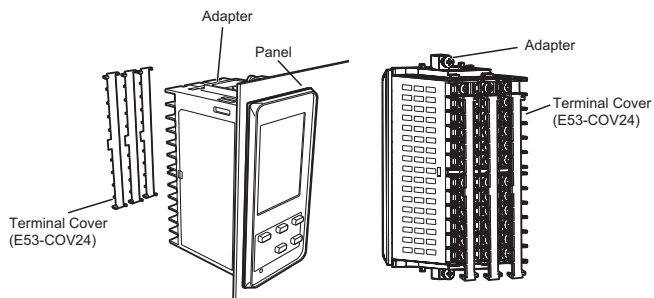

1. For waterproof mounting, waterproof packing must be installed on the Digital Temperature Controller. Waterproofing is not possible when group mounting several Digital Temperature Controllers.
2. Insert the E5EC-800/E5EC-B-800/E5AC-800 into the mounting hole in the panel.
3. Push the adapter from the terminals up to the panel, and temporarily fasten the E5EC-800/E5EC-B-800/E5AC-800.
4. Tighten the two fastening screws on the adapter. Alternately tighten the two screws little by little to maintain a balance. Tighten the screws to a torque of 0.29 to 0.39 N·m.

E5DC-800/E5DC-B-800

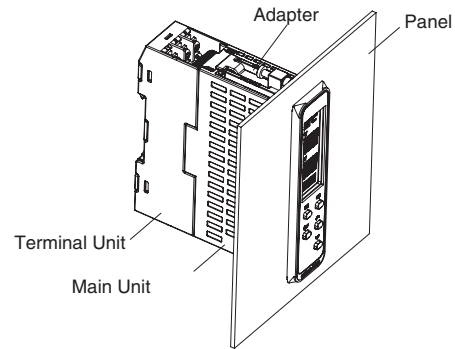

1. Insert the E5DC-800/E5DC-B-800 into the mounting hole in the panel. (Attach the Terminal Unit after you insert the Main Unit.)
2. Push the Adapter from the Terminal Unit up to the panel, and temporarily fasten the E5DC-800/E5DC-B-800.
3. Tighten the two fastening screws on the Adapter. Alternately tighten the two screws little by little to maintain a balance. Tighten the screws to a torque of 0.29 to 0.39 N·m.

E5DC-800

Mounting to and Removing from DIN Track

- Mounting a Unit

Pull down the DIN Track hook on the Terminal Unit and catch the top hook on the DIN Track.

Press the Unit onto the DIN Track until the DIN Track hooks are locked in place.

2. Catch the top hook on the DIN Track.

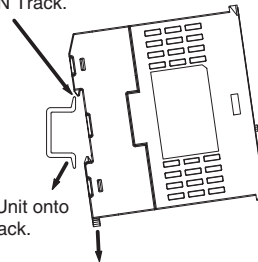

3. Press the Unit onto the DIN Track.

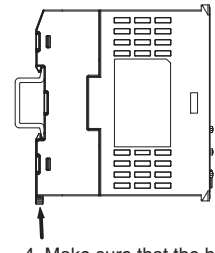

1. Pull down the hook.

4. Make sure that the hooks are locked in place.

- Removing a Unit

Pull down on the DIN Track Hook with a flat-blade screwdriver and lift up the Unit.

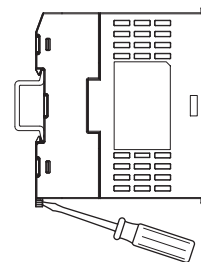

Removing the Main Unit

Press in the two hooks on the Main Unit and remove the Main Unit from the Terminal Unit.

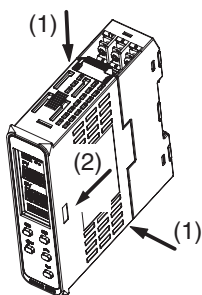

Removing the Main Unit

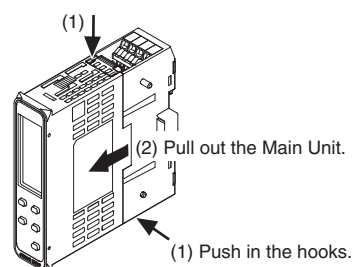

End Plate Installation

Make sure to attach PFP-M End Plates to the ends of the Units.

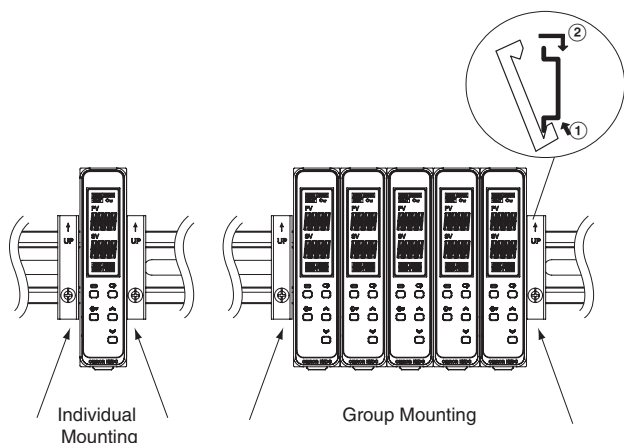

End Plate Installation

Make sure to attach PFP-M End Plates to the ends of the Units.

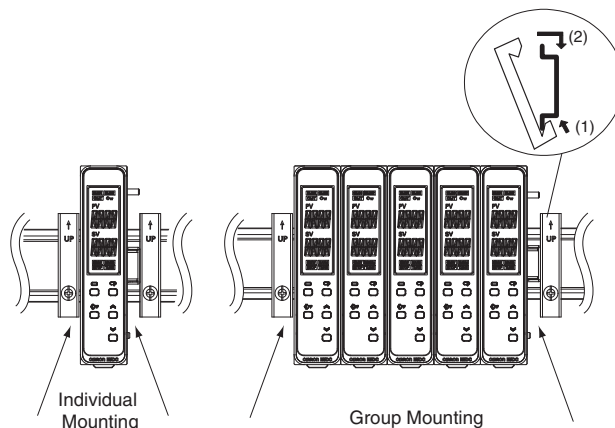

E5DC-B-800

Mounting to and Removing from DIN Track

• Mounting a Unit

Mount the Main Unit after first mounting the Terminal Unit on the DIN Track.

- (2) Catch the top hook on the DIN Track.

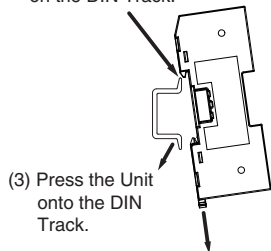

- (3) Press the Unit onto the DIN Track.

- (1) Pull down the hook.

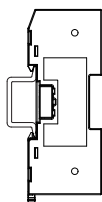

- (4) Make sure that the hooks are locked in place.

• Removing a Unit

Pull down on the DIN Track Hook with a flat-blade screwdriver and lift the Unit.

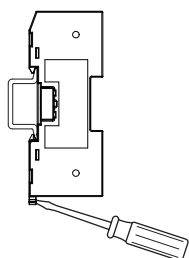

Mounting to a DIN Track in Connection

1. Remove the connector cover on the side to use for connecting to another terminal unit, and attach the unit to the DIN Track.
2. Connect the terminal unit connector to the next unit.

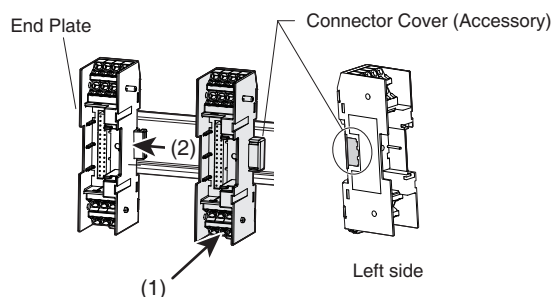

3. Wire the terminal units.
4. Insert the main units into the terminal units.

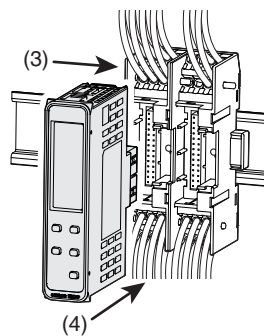

Removing from the DIN Track

1. Remove the Main Unit from the Terminal Unit.
2. Remove the Terminal Units.

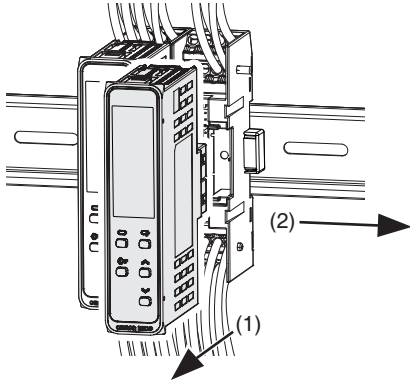

3. Remove the Terminal Units from the DIN Track.

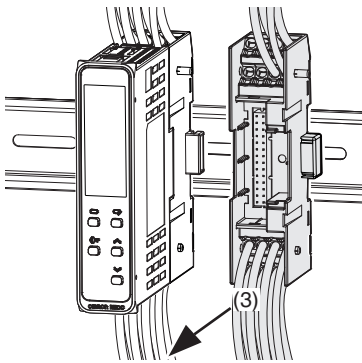

Mounting to a Panel in Connection

1. Insert the main unit into the mounting hole in the panel.
2. Mount the previously rewired terminal unit to the main unit.
3. Push the adapter from the terminal unit side until it comes into contact with the panel to temporarily secure the unit, and then tighten the two fastening screws on the adapter. Alternately tighten the two screws little by little to maintain a balance. Tighten the screws to a torque of 0.29 to 0.39 N·m.

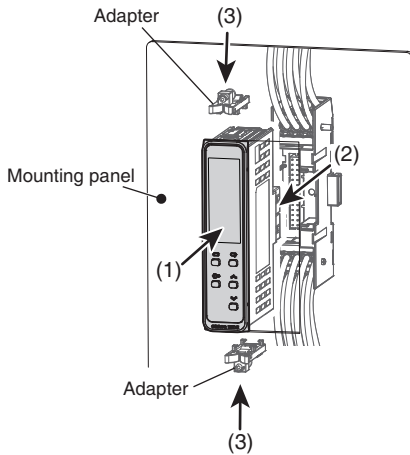

4. On the wired terminal unit, remove the connector cover on the side to use for connection to another terminal unit, and then connect the units together.

5. Insert the main unit into the mounting hole in the panel, and then mount the terminal unit.

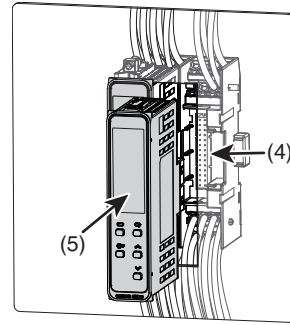

6. Push the adapter from the terminal unit side until it comes into contact with the panel to temporarily secure the unit, and then tighten the two fastening screws on the adapter. Alternately tighten the two screws little by little to maintain a balance. Tighten the screws to a torque of 0.29 to 0.39 N·m.

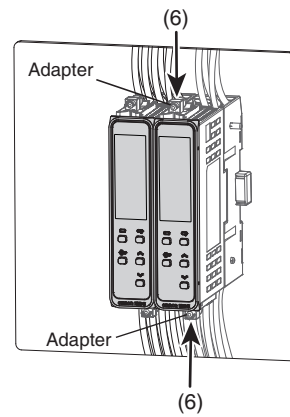

Removing from the Mounting Panel

1. Remove the Adapter attached to the Main Unit.

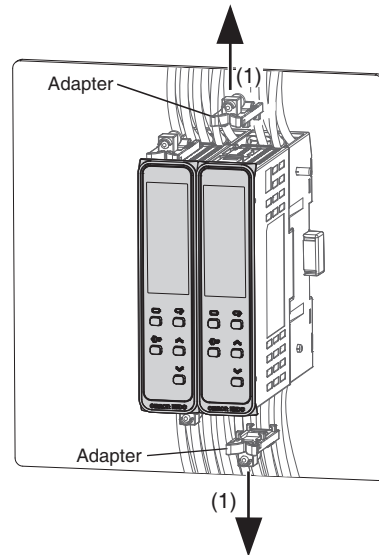

2. Remove the Main Unit from the Terminal Unit.

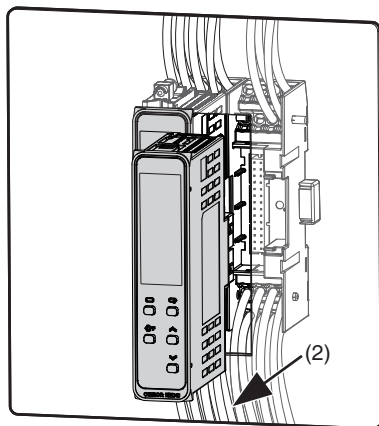

3. Remove the Terminal Units.

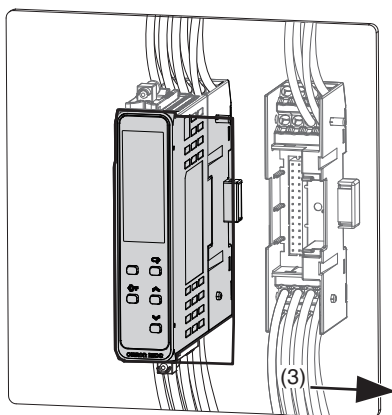

Removing the Connector Cover
E5DC-B-800

1. For both male and female covers, insert the tip of a flat-blade screwdriver into the cutout on the connector cover to remove the connector cover.

Male connector cover

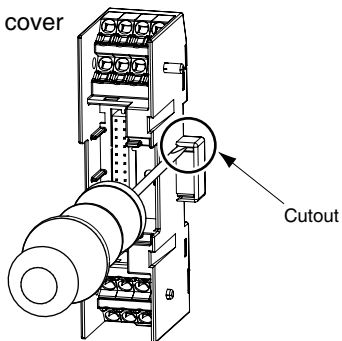

Female connector cover

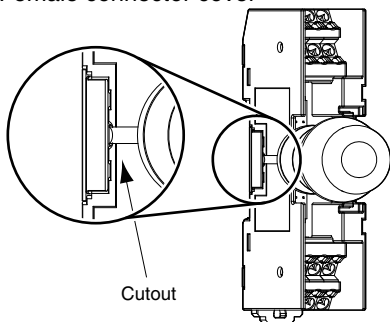

Attaching the Connector Cover
E5DC-B-800

For male connector covers

1. Press on the connector cover until it clicks into place. There is no vertical direction for male connector covers.

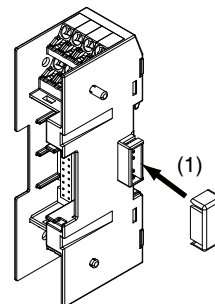

For female connector covers

1. Insert the projecting part on the female connector cover into the groove on the terminal unit.

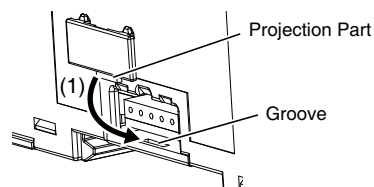

2. Press on the female connector cover until it clicks into place in the cutout.

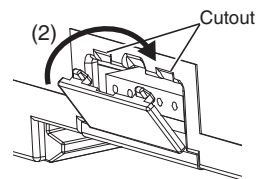

Mounting the DIN Track

Attach the DIN Track to the inside of the control panel with screws to at least three locations.

- DIN Track (sold separately)
PFP-50N (50 cm) and PFP-100N (100 cm)

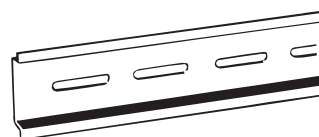

Install the DIN Track vertically to the ground.

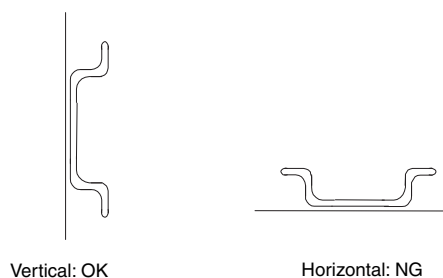

Mounting the Terminal Cover E5CC-800

Slightly bend the E53-COV23 Terminal Cover to attach it to the terminal block as shown in the following diagram. The Terminal Cover cannot be attached in the opposite direction. E53-COV17 Terminal Cover can be also attached.

Make sure that the "UP" mark is facing up, and then attach the E53-COV17 Terminal Cover to the holes on the top and bottom of the Digital Temperature Controller.

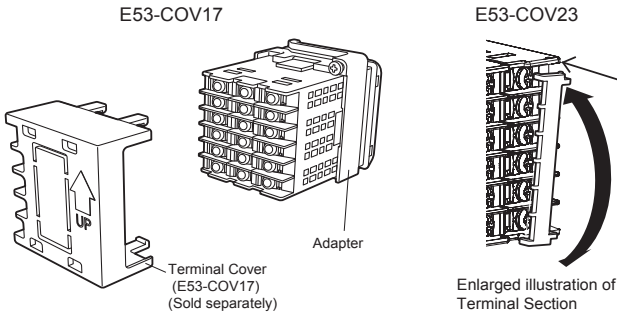

E5EC-800/E5AC-800

Slightly bend the E53-COV24 Terminal Cover to attach it to the terminal block as shown in the following diagram. The Terminal Cover cannot be attached in the opposite direction.

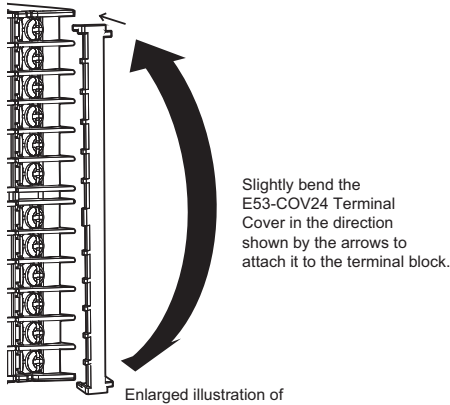

Attaching the End Cover E5DC-800/E5DC-B-800

1. Install the E5DC-800/E5DC-B-800 in a panel.

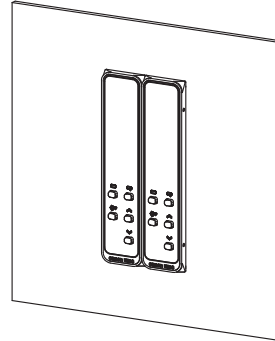

2. Peel off the release paper from the double-sided tape on the End Cover.

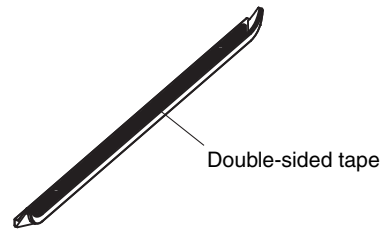

3. Align the tabs on the End Cover with the depressions on the E5DC-800/E5DC-B-800 and attach the End Cover.

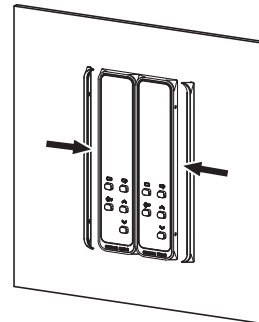
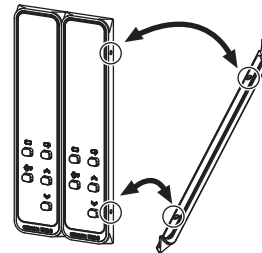

4. Secure the End Cover so that the double-sided tape is firmly attached.

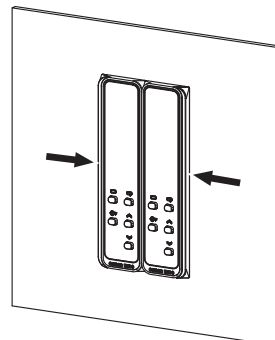

Precautions when Wiring

- Separate input leads and power lines in order to prevent external noise.
- Use crimp terminals when wiring the screw terminal blocks.
- Use the suitable wiring material and crimp tools for crimp terminals.
- Tighten the terminal screws to a torque of 0.43 to 0.58 N·m. The specified torque is 0.5 N·m for the E5CC-U-800.

E5CC-800/E5EC-800/E5AC-800/E5DC-800 (Controllers with Screw Terminal Blocks) and E5CC-U-800 (Plug-in model)

Wire Size

Use the wire sizes and stripping lengths given in the following table.

Model	Wire Size	Stripping length
E5CC-800/E5EC-800/E5AC-800/E5DC-800 (Controllers with Screw Terminal Blocks)	AWG24 to AWG18 (0.21 to 0.82 mm ²)	6 to 8 mm (without crimp terminals)
E5CC-U-800	AWG24 to AWG14 (0.21 to 2.08 mm ²)	5 to 6 mm (without crimp terminals)

- If you use crimp terminals, use the stripping length that is recommended by the manufacturer of the crimp terminals.
- To reduce the affects of noise, use shielded twisted-pair cable for the signal lines.

Crimp Terminal

For the E5CC-800/E5EC-800/E5AC-800/E5DC-800 (Controllers with Screw Terminal Blocks), use the following of crimp terminals for M3 screws.

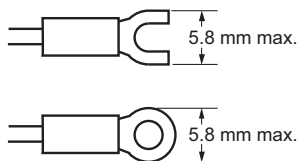

For the E5CC-U-800, use the following types of crimp terminals for M3.5 screws.

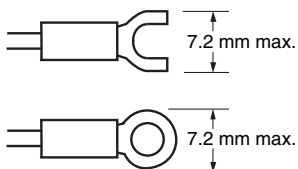

- If you use crimp terminals for the E5DC-800, use crimp terminals with insulation sleeves. If you use a bare crimp terminal with no insulation, the terminal may short with the terminal above or below it. If you use bare crimp terminals, cover the crimped sections with insulating marking tubes. Secure the marking tubes so that they do not move.

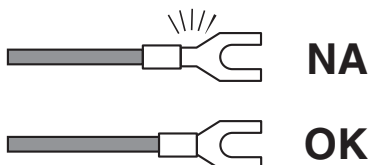

Although you can connect two crimp terminals with insulation sleeves to one terminal, you cannot do so if the diameter of the insulation sleeves is too large.

Recommended Crimp Terminals with Insulation Sleeves for the E5DC-800

Manufacturer	Model number
J.S.T. Mfg. Co.	V1.25-B3A V0.5-3A

E5□C-B-800 (Controllers with Push-In Plus Terminal Blocks)

1. Connecting Wires to the Push-In Plus Terminal Block Part Names of the Terminal Block

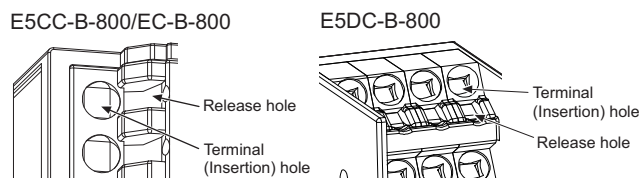

Connecting Wires with Ferrules and Solid Wires

Insert the solid wire or ferrule straight into the terminal block until the end strikes the terminal block.

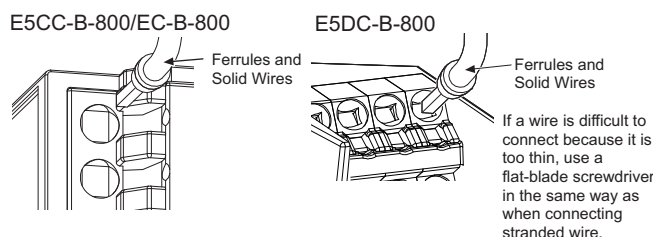

If a wire is difficult to connect because it is too thin, use a flat-blade screwdriver in the same way as when connecting stranded wire.

Connecting Stranded Wires

Use the following procedure to connect the wires to the terminal block.

1. Hold a flat-blade screwdriver at an angle and insert it into the release hole. The angle should be between 10° and 15°. If the flat-blade screwdriver is inserted correctly, you will feel the spring in the release hole.
2. With the flat-blade screwdriver still inserted into the release hole, insert the wire into the terminal hole until it strikes the terminal block.
3. Remove the flat-blade screwdriver from the release hole.

E5CC-B-800/EC-B-800

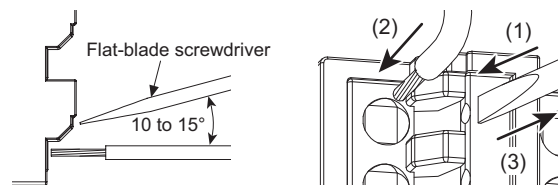

E5DC-B-800

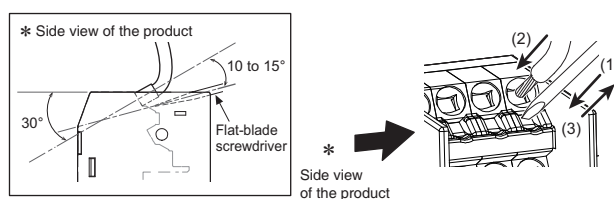

Checking Connections

- After the insertion, pull gently on the wire to make sure that it will not come off and the wire is securely fastened to the terminal block.
- If you use a ferrule with a conductor length of 10 mm, part of the conductor may be visible after the ferrule is inserted into the terminal block, but the product insulation distance will still be satisfied.

2. Removing Wires from the Push-In Plus Terminal Block

Use the following procedure to remove wires from the terminal block. The same method is used to remove stranded wires, solid wires, and ferrules.

1. Hold a flat-blade screwdriver at an angle and insert it into the release hole.
2. With the flat-blade screwdriver still inserted into the release hole, remove the wire from the terminal insertion hole.
3. Remove the flat-blade screwdriver from the release hole.

E5CC-B-800/EC-B-800

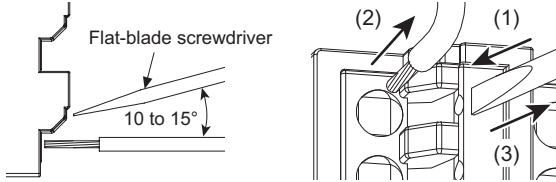

E5DC-B-800

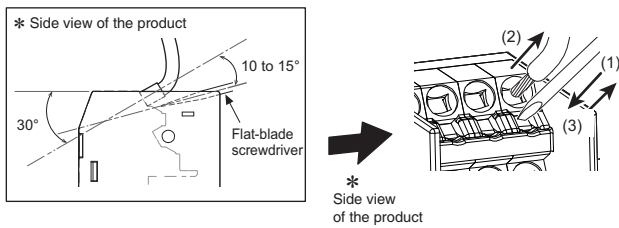

Recommended Flat-blade Screwdriver

Use a flat-blade screwdriver to connect and remove wires. Use the following flat-blade screwdriver.

The following table shows manufacturers and models as of 2015/Dec.

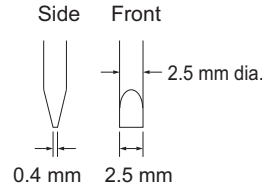

Model	Manufacturer
ESD 0,40x2,5	Wera
SZS 0,4x2,5 SZF 0-0,4x2,5 *	Phoenix Contact
0,4x2,5x75 302	Wiha
AEF.2,5x75	Facom
210-719	Wago
SDIS 0,4x2,5x75	Weidmuller
9900 (-2,5x75)	Vessel

* OMRON's exclusive purchase model XW4Z-00B is available to order as SZF 0-0,4 x 2,5 (manufactured by Phoenix Contact).

3. Recommended Ferrules and Crimp Tools

Recommended ferrules

Applicable wire		Ferrule Conductor length (mm)	Wire Stripping length (mm) (Ferrules used)	Recommended ferrules		
(mm ²)	(AWG)			Phoenix Contact product	Weidmuller product	Wago product
0.25	24	8	10	AI 0,25-8	H0.25/12	216-301
		10	12	AI 0,25-10	---	---
0.34	22	8	10	AI 0,34-8	H0.34/12	216-302
		10	12	AI 0,34-10	---	---
0.5	20	8	10	AI 0,5-8	H0.5/14	216-201
		10	12	AI 0,5-10	H0.5/16	216-241
0.75	18	8	10	AI 0,75-8	H0.75/14	216-202
		10	12	AI 0,75-10	H0.75/16	216-242
1/1.25	18/17	8	10	AI 1-8	H1.0/14	216-203
		10	12	AI 1-10	H1.0/16	216-243
1.25/1.5	17/16	8	10	AI 1,5-8	H1.5/14	216-204
		10	12	AI 1,5-10	H1.5/16	216-244
Recommended crimp tool				CRIMPFOX6 CRIMPFOX6T-F CRIMPFOX10S	PZ6 roto	Variocrimp4

- Note:**
1. Make sure that the outer diameter of the wire coating is smaller than the inner diameter of the insulation sleeve of the recommended ferrule.
 2. Make sure that the ferrule processing dimensions conform to the following figures.

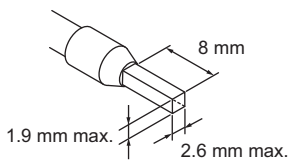

Terms and Conditions Agreement

Read and understand this catalog.

Please read and understand this catalog before purchasing the products. Please consult your OMRON representative if you have any questions or comments.

Warranties.

- (a) Exclusive Warranty. Omron's exclusive warranty is that the Products will be free from defects in materials and workmanship for a period of twelve months from the date of sale by Omron (or such other period expressed in writing by Omron). Omron disclaims all other warranties, express or implied.
- (b) Limitations. OMRON MAKES NO WARRANTY OR REPRESENTATION, EXPRESS OR IMPLIED, ABOUT NON-INFRINGEMENT, MERCHANTABILITY OR FITNESS FOR A PARTICULAR PURPOSE OF THE PRODUCTS. BUYER ACKNOWLEDGES THAT IT ALONE HAS DETERMINED THAT THE PRODUCTS WILL SUITABLY MEET THE REQUIREMENTS OF THEIR INTENDED USE.

Omron further disclaims all warranties and responsibility of any type for claims or expenses based on infringement by the Products or otherwise of any intellectual property right. (c) Buyer Remedy. Omron's sole obligation hereunder shall be, at Omron's election, to (i) replace (in the form originally shipped with Buyer responsible for labor charges for removal or replacement thereof) the non-complying Product, (ii) repair the non-complying Product, or (iii) repay or credit Buyer an amount equal to the purchase price of the non-complying Product; provided that in no event shall Omron be responsible for warranty, repair, indemnity or any other claims or expenses regarding the Products unless Omron's analysis confirms that the Products were properly handled, stored, installed and maintained and not subject to contamination, abuse, misuse or inappropriate modification. Return of any Products by Buyer must be approved in writing by Omron before shipment. Omron Companies shall not be liable for the suitability or unsuitability or the results from the use of Products in combination with any electrical or electronic components, circuits, system assemblies or any other materials or substances or environments. Any advice, recommendations or information given orally or in writing, are not to be construed as an amendment or addition to the above warranty.

See <http://www.omron.com/global/> or contact your Omron representative for published information.

Limitation on Liability: Etc.

OMRON COMPANIES SHALL NOT BE LIABLE FOR SPECIAL, INDIRECT, INCIDENTAL, OR CONSEQUENTIAL DAMAGES, LOSS OF PROFITS OR PRODUCTION OR COMMERCIAL LOSS IN ANY WAY CONNECTED WITH THE PRODUCTS, WHETHER SUCH CLAIM IS BASED IN CONTRACT, WARRANTY, NEGLIGENCE OR STRICT LIABILITY.

Further, in no event shall liability of Omron Companies exceed the individual price of the Product on which liability is asserted.

Suitability of Use.

Omron Companies shall not be responsible for conformity with any standards, codes or regulations which apply to the combination of the Product in the Buyer's application or use of the Product. At Buyer's request, Omron will provide applicable third party certification documents identifying ratings and limitations of use which apply to the Product. This information by itself is not sufficient for a complete determination of the suitability of the Product in combination with the end product, machine, system, or other application or use. Buyer shall be solely responsible for determining appropriateness of the particular Product with respect to Buyer's application, product or system. Buyer shall take application responsibility in all cases.

NEVER USE THE PRODUCT FOR AN APPLICATION INVOLVING SERIOUS RISK TO LIFE OR PROPERTY OR IN LARGE QUANTITIES WITHOUT ENSURING THAT THE SYSTEM AS A WHOLE HAS BEEN DESIGNED TO ADDRESS THE RISKS, AND THAT THE OMRON PRODUCT(S) IS PROPERLY RATED AND INSTALLED FOR THE INTENDED USE WITHIN THE OVERALL EQUIPMENT OR SYSTEM.

Programmable Products.

Omron Companies shall not be responsible for the user's programming of a programmable Product, or any consequence thereof.

Performance Data.

Data presented in Omron Company websites, catalogs and other materials is provided as a guide for the user in determining suitability and does not constitute a warranty. It may represent the result of Omron's test conditions, and the user must correlate it to actual application requirements. Actual performance is subject to the Omron's Warranty and Limitations of Liability.

Change in Specifications.

Product specifications and accessories may be changed at any time based on improvements and other reasons. It is our practice to change part numbers when published ratings or features are changed, or when significant construction changes are made. However, some specifications of the Product may be changed without any notice. When in doubt, special part numbers may be assigned to fix or establish key specifications for your application. Please consult with your Omron's representative at any time to confirm actual specifications of purchased Product.

Errors and Omissions.

Information presented by Omron Companies has been checked and is believed to be accurate; however, no responsibility is assumed for clerical, typographical or proofreading errors or omissions.

Note: Do not use this document to operate the Unit.

OMRON Corporation Industrial Automation Company

Kyoto, JAPAN

Contact : www.ia.omron.com

Regional Headquarters

OMRON EUROPE B.V.

Wegalaan 67-69, 2132 JD Hoofddorp
The Netherlands
Tel: (31) 2356-81-300 Fax: (31) 2356-81-388

OMRON ELECTRONICS LLC

2895 Greenspoint Parkway, Suite 200
Hoffman Estates, IL 60169 U.S.A.
Tel: (1) 847-843-7900 Fax: (1) 847-843-7787

OMRON ASIA PACIFIC PTE. LTD.

438B Alexandra Road, #08-01/02 Alexandra
Technopark, Singapore 119968
Tel: (65) 6835-3011 Fax: (65) 6835-3011

OMRON (CHINA) CO., LTD.

Room 2211, Bank of China Tower,
200 Yin Cheng Zhong Road,
PuDong New Area, Shanghai, 200120, China
Tel: (86) 21-6023-0333 Fax: (86) 21-5037-2388

Authorized Distributor:

©OMRON Corporation 2011-2025 All Rights Reserved.
In the interest of product improvement,
specifications are subject to change without notice.

CSM_5_7

Cat. No. H179-E1-12 1225 (1111)